

## DESCRIPTION:

With high ability to withstand the shock loading of large current, BTA12-600BW series triacs provide high dv/dt rate with strong resistance to electromagnetic interference. With high commutation performances, 3 quadrants products especially recommended for use on inductive load.

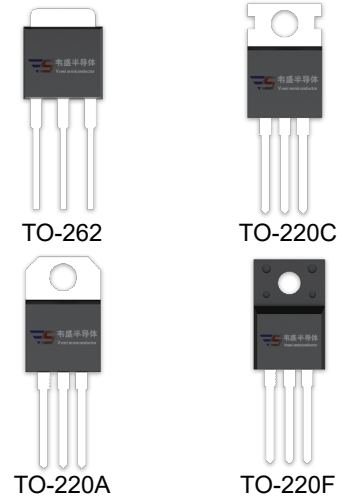

## MAIN FEATURES

Symbol	Value	Unit
$I_{T(RMS)}$	12	A
$V_{DRM}/V_{RRM}$	600/800/1200	V

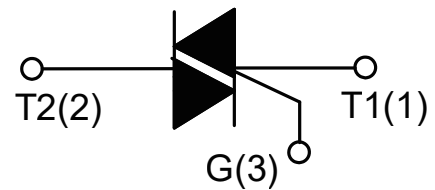

## ABSOLUTE MAXIMUM RATINGS

Parameter		Symbol	Value	Unit
Storage junction temperature range		$T_{stg}$	-40-150	°C
Operating junction temperature range		$T_j$	-40-125	°C
Repetitive peak off-state voltage ( $T_j=25^\circ\text{C}$ )		$V_{DRM}$	600/800/1200	V
Repetitive peak reverse voltage ( $T_j=25^\circ\text{C}$ )		$V_{RRM}$	600/800/1200	V
Non repetitive surge peak Off-state voltage		$V_{DSM}$	$V_{DRM} + 100$	V
Non repetitive peak reverse voltage		$V_{RSM}$	$V_{RRM} + 100$	V
RMS on-state current	TO-220A(Ins) ( $T_c=85^\circ\text{C}$ )	$I_{T(RMS)}$	12	A
	TO-262/ TO-220A(Non-Ins)/ TO-220C( $T_c=100^\circ\text{C}$ )			
	TO-220F(Ins) ( $T_c=80^\circ\text{C}$ )			

Non repetitive surge peak on-state current (full cycle, F=50Hz)		$I_{TSM}$	120	A
$I^2t$ value for fusing ( $t_p=10ms$ )		$I^2t$	78	$A^2s$
Critical rate of rise of on-state current ( $I_G=2 \times I_{GT}$ )	I - II -III	$di/dt$	50	$A/\mu s$
Peak gate current		$I_{GM}$	4	A
Average gate power dissipation		$P_{G(AV)}$	1	W
Peak gate power		$P_{GM}$	5	W

**ELECTRICAL CHARACTERISTICS** ( $T_j=25^\circ C$  unless otherwise specified)

## 3 Quadrants

Symbol	Test Condition	Quadrant		Value				Unit
				BW	CW	SW	TW	
$I_{GT}$	$V_D=12V R_L=33\Omega$	I - II -III	MAX	50	35	10	5	mA
$V_{GT}$		I - II -III	MAX	1.3				V
$V_{GD}$	$V_D=V_{DRM} T_j=125^\circ C$ $R_L=3.3K\Omega$	I - II -III	MIN	0.2				V
$I_L$	$I_G=1.2I_{GT}$	I -III	MAX	80	50	30	20	mA
		II		90	60	40	30	
$I_H$	$I_T=100mA$		MAX	60	40	20	15	mA
$dV/dt$	$V_D=2/3V_{DRM}$ Gate Open $T_j=125^\circ C$		MIN	1000	500	200	100	$V/\mu s$
$(di/dt)_c$	Without snubber $T_j=125^\circ C$		MIN	12	6.5	-	-	$A/ms$

## 4 Quadrants

Symbol	Test Condition	Quadrant		Value		Unit
				B	C	
$I_{GT}$	$V_D=12V R_L=33\Omega$	I - II -III	MAX	50	25	mA
		IV		70	50	
$V_{GT}$		ALL	MAX	1.3		V
$V_{GD}$	$V_D=V_{DRM} T_j=125^\circ C$ $R_L=3.3K\Omega$	ALL	MIN	0.2		V
$I_L$	$I_G=1.2I_{GT}$	I -III-IV	MAX	50	40	mA
		II		100	80	

$I_H$	$I_T=100\text{mA}$	MAX	50	25	mA
$dV/dt$	$V_D=2/3V_{\text{DRM}}$ Gate Open $T_j=125^\circ\text{C}$	MIN	500	200	V/ $\mu\text{s}$
$(dV/dt)_c$	$(dI/dt)_c=5.3\text{A/ms}$ $T_j=125^\circ\text{C}$	MIN	10	5	V/ $\mu\text{s}$

### STATIC CHARACTERISTICS

Symbol	Parameter		Value(MAX)	Unit
$V_{\text{TM}}$	$I_{\text{TM}}=17\text{A}$ $t_p=380\mu\text{s}$	$T_j=25^\circ\text{C}$	1.5	V
$I_{\text{DRM}}$	$V_D=V_{\text{DRM}}$ $V_R=V_{\text{RRM}}$	$T_j=25^\circ\text{C}$	5	$\mu\text{A}$
$I_{\text{RRM}}$		$T_j=125^\circ\text{C}$	1	mA

### THERMAL RESISTANCES

Symbol	Parameter		Value	Unit
$R_{\text{th}(j-c)}$	junction to case(AC)	TO-220A(Ins)	2.3	$^\circ\text{C}/\text{W}$
		TO-262/ TO-220A(Non-Ins)/ TO-220C	1.4	
		TO-220F(Ins)	2.5	

**FIG.1** Maximum power dissipation versus RMS on-state current

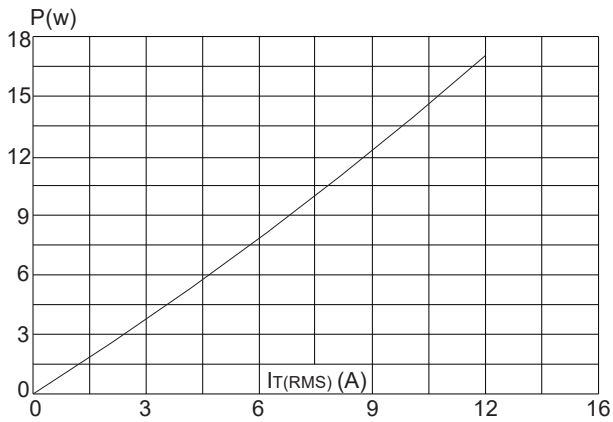

**FIG.2:** RMS on-state current versus case temperature

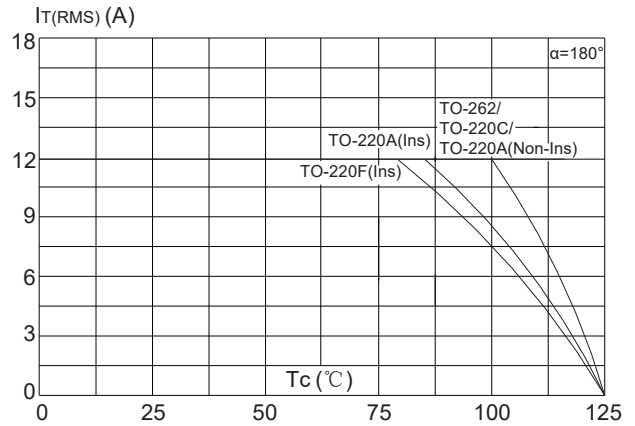

**FIG.3:** Surge peak on-state current versus number of cycles

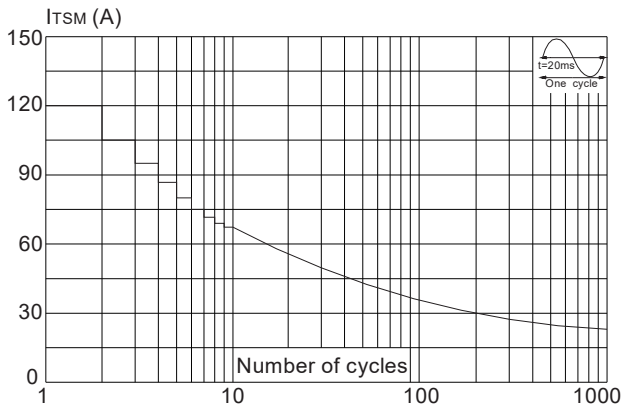

**FIG.4:** On-state characteristics (maximum values)

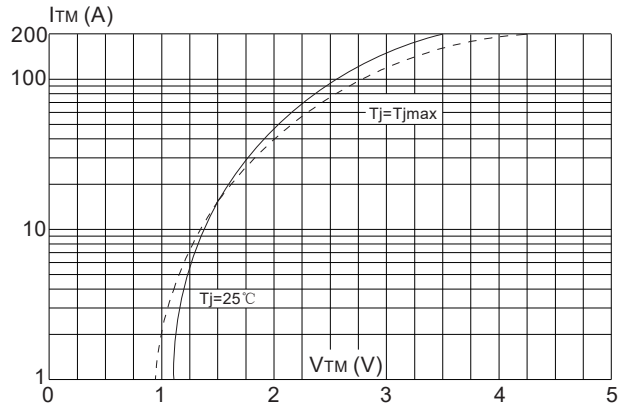

**FIG.5:** Non-repetitive surge peak on-state current for a sinusoidal pulse with width  $t_p < 20\text{ms}$ , and corresponding value of  $I^2t$  ( $dI/dt(I-II-III) < 50\text{A}/\mu\text{s}$ )

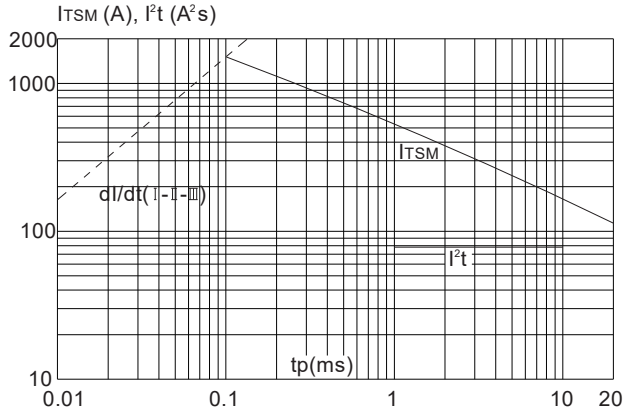

**FIG.6:** Relative variations of gate trigger current, holding current and latching current versus junction temperature

