

DESCRIPTION:

With high ability to withstand the shock loading of large current, BTA12-600CW series triacs provide high dv/dt rate with strong resistance to electromagnetic interface. With high commutation performances, 3 quadrants products especially recommended for use on inductive load.

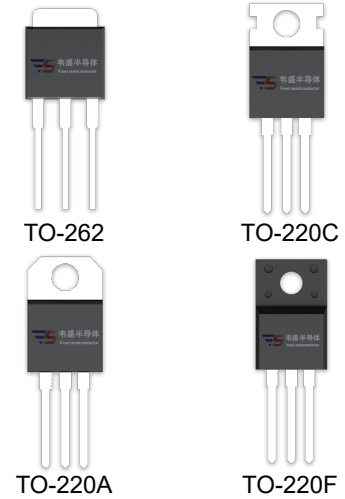

MAIN FEATURES

Symbol	Value	Unit
$I_{T(RMS)}$	12	A
V_{DRM}/V_{RRM}	600/800/1200	V

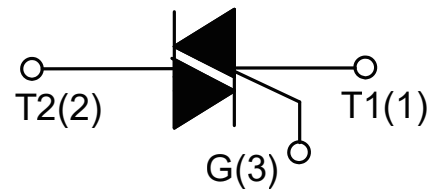

ABSOLUTE MAXIMUM RATINGS

Parameter		Symbol	Value	Unit
Storage junction temperature range		T_{stg}	-40-150	°C
Operating junction temperature range		T_j	-40-125	°C
Repetitive peak off-state voltage ($T_j=25^\circ\text{C}$)		V_{DRM}	600/800/1200	V
Repetitive peak reverse voltage ($T_j=25^\circ\text{C}$)		V_{RRM}	600/800/1200	V
Non repetitive surge peak Off-state voltage		V_{DSM}	$V_{DRM} + 100$	V
Non repetitive peak reverse voltage		V_{RSM}	$V_{RRM} + 100$	V
RMS on-state current	TO-220A(Ins) ($T_c=85^\circ\text{C}$)	$I_{T(RMS)}$	12	A
	TO-262/ TO-220A(Non-Ins)/ TO-220C($T_c=100^\circ\text{C}$)			
	TO-220F(Ins) ($T_c=80^\circ\text{C}$)			

Non repetitive surge peak on-state current (full cycle, F=50Hz)		I_{TSM}	120	A
I^2t value for fusing (tp=10ms)		I^2t	78	A ² s
Critical rate of rise of on-state current ($I_G=2 \times I_{GT}$)	I - II -III	dI/dt	50	A/ μ s
Peak gate current		I_{GM}	4	A
Average gate power dissipation		$P_{G(AV)}$	1	W
Peak gate power		P_{GM}	5	W

ELECTRICAL CHARACTERISTICS ($T_j=25^\circ\text{C}$ unless otherwise specified)

3 Quadrants

Symbol	Test Condition	Quadrant		Value				Unit
				BW	CW	SW	TW	
I_{GT}	$V_D=12V R_L=33\Omega$	I - II -III	MAX	50	35	10	5	mA
V_{GT}		I - II -III	MAX	1.3				V
V_{GD}	$V_D=V_{DRM} T_j=125^\circ\text{C}$ $R_L=3.3K\Omega$	I - II -III	MIN	0.2				V
I_L	$I_G=1.2I_{GT}$	I -III	MAX	80	50	30	20	mA
		II		90	60	40	30	
I_H	$I_T=100\text{mA}$		MAX	60	40	20	15	mA
dV/dt	$V_D=2/3V_{DRM}$ Gate Open $T_j=125^\circ\text{C}$		MIN	1000	500	200	100	V/ μ s
(dI/dt) _c	Without snubber $T_j=125^\circ\text{C}$		MIN	12	6.5	-	-	A/ms

4 Quadrants

Symbol	Test Condition	Quadrant		Value		Unit
				B	C	
I_{GT}	$V_D=12V R_L=33\Omega$	I - II -III	MAX	50	25	mA
		IV		70	50	
V_{GT}		ALL	MAX	1.3		V
V_{GD}	$V_D=V_{DRM} T_j=125^\circ\text{C}$ $R_L=3.3K\Omega$	ALL	MIN	0.2		V
I_L	$I_G=1.2I_{GT}$	I -III-IV	MAX	50	40	mA
		II		100	80	

I_H	$I_T = 100\text{mA}$	MAX	50	25	mA
dV/dt	$V_D = 2/3V_{DRM}$ Gate Open $T_j = 125^\circ\text{C}$	MIN	500	200	V/ μs
$(dV/dt)_c$	$(dI/dt)_c = 5.3\text{A/ms}$ $T_j = 125^\circ\text{C}$	MIN	10	5	V/ μs

STATIC CHARACTERISTICS

Symbol	Parameter		Value(MAX)	Unit
V_{TM}	$I_{TM} = 17\text{A}$ $t_p = 380\mu\text{s}$	$T_j = 25^\circ\text{C}$	1.5	V
I_{DRM}	$V_D = V_{DRM}$ $V_R = V_{RRM}$	$T_j = 25^\circ\text{C}$	5	μA
I_{RRM}		$T_j = 125^\circ\text{C}$	1	mA

THERMAL RESISTANCES

Symbol	Parameter		Value	Unit
$R_{th(j-c)}$	junction to case(AC)	TO-220A(Ins)	2.3	$^\circ\text{C/W}$
		TO-262/ TO-220A(Non-Ins)/ TO-220C	1.4	
		TO-220F(Ins)	2.5	

FIG.1 Maximum power dissipation versus RMS on-state current

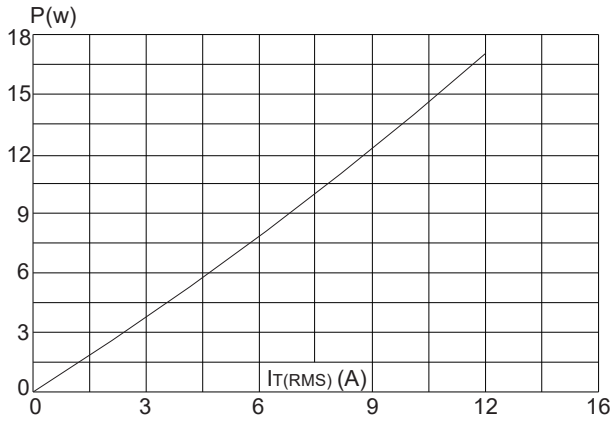

FIG.2: RMS on-state current versus case temperature

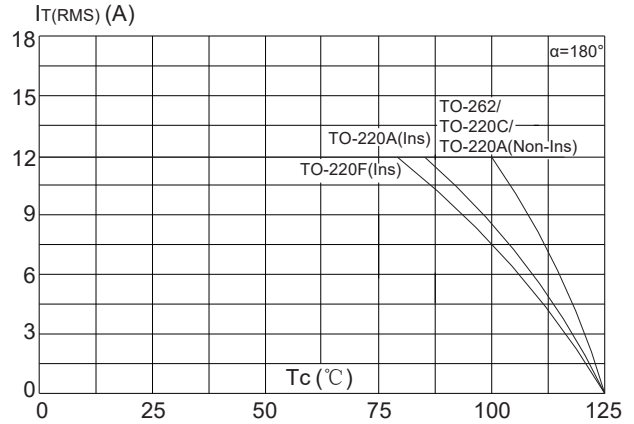

FIG.3: Surge peak on-state current versus number of cycles

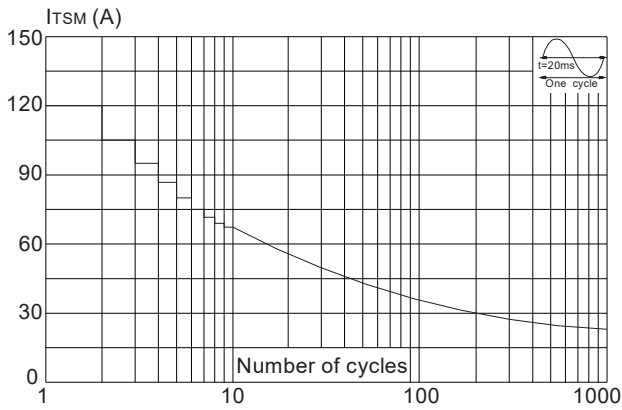

FIG.4: On-state characteristics (maximum values)

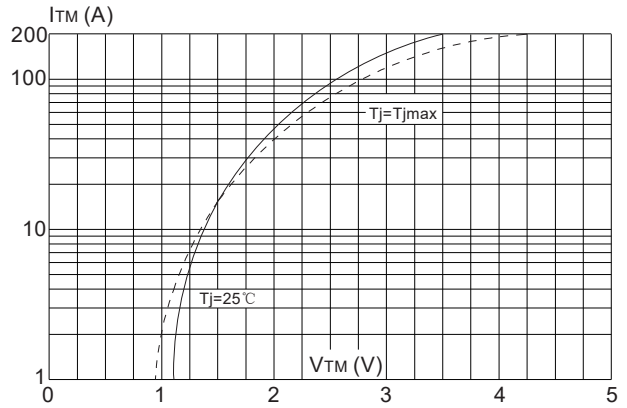

FIG.5: Non-repetitive surge peak on-state current for a sinusoidal pulse with width $t_p < 20\text{ms}$, and corresponding value of I^2t ($dI/dt(I-II-III) < 50\text{A}/\mu\text{s}$)

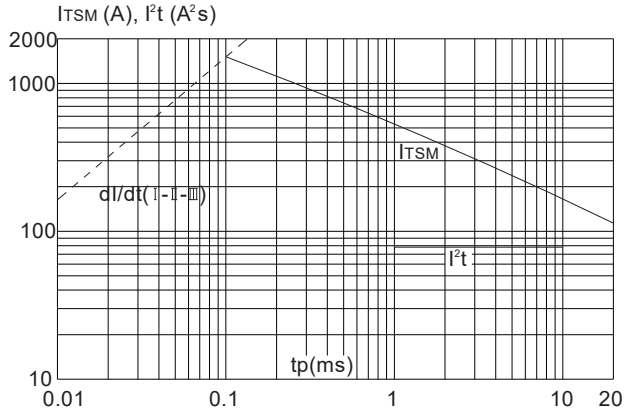

FIG.6: Relative variations of gate trigger current, holding current and latching current versus junction temperature

