





<p>Description</p> <p>The Power MOSFET is fabricated using the advanced planer VDMOS technology. The resulting device has low conduction resistance, superior switching performance and high avalanche energy.</p> <p>Features</p> <ul style="list-style-type: none"> ◆ Low $R_{DS(on)}$ ◆ Low gate charge (typ. $Q_g = 10.2$ nC) ◆ 100% UIS tested ◆ RoHS compliant <p>Applications</p> <ul style="list-style-type: none"> ◆ Power factor correction. ◆ Switched mode power supplies. ◆ LED driver. 	<p>Product Summary</p> <p>V_{DSS} 600V</p> <p>I_D 2A</p> <p>$R_{DS(on),max}$ 4.5Ω</p> <p>$Q_{g,typ}$ 10.2 nC</p> <div style="display: flex; justify-content: space-around; align-items: center;"> <div style="text-align: center;">  <p>TO-251</p> </div> <div style="text-align: center;">  <p>TO-252</p> </div> <div style="text-align: center;">  <p>TO-220F</p> </div> </div> <div style="display: flex; justify-content: space-around; align-items: center;"> <div style="text-align: center;">  <p>TO-220C</p> </div> <div style="text-align: center;">  <p>Schematic</p> </div> </div>
--	---

Absolute Maximum Ratings

Parameter	Symbol	Value	Unit
Drain-Source Voltage	V_{DSS}	600	V
Continuous drain current ($T_C = 25^\circ\text{C}$)	I_D	2	A
($T_C = 100^\circ\text{C}$)		1.3	A
Pulsed drain current ¹⁾	I_{DM}	8	A
Gate-Source voltage	V_{GSS}	± 30	V
Avalanche energy, single pulse ²⁾	E_{AS}	80	mJ
Peak diode recovery dv/dt ³⁾	dv/dt	5	V/ns
Power Dissipation C TO-220F ($T_C = 25^\circ\text{C}$)	P_D	27	W
Derate above 25°C		0.22	W/ $^\circ\text{C}$
Power Dissipation C TO-220\TO-251\ TO-252 ($T_C = 25^\circ\text{C}$)		35	W
Derate above 25°C		0.28	W/ $^\circ\text{C}$
Operating junction and storage temperature range	T_J, T_{STG}	-55 to +150	$^\circ\text{C}$
Continuous diode forward current	I_S	2	A
Diode pulse current	$I_{S,pulse}$	8	A

Thermal Characteristics

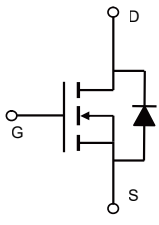
Parameter	Symbol	Value		Unit
		C TO-220F	C TO-220\TO-251\TO-252	
Thermal resistance, Junction-to-case	$R_{\theta JC}$	4.63	3.57	$^\circ\text{C}/\text{W}$
Thermal resistance, Junction-to-ambient	$R_{\theta JA}$	100	62	$^\circ\text{C}/\text{W}$

Package Marking and Ordering Information

Device	Device Package	Marking	Units/Tube	Units/Real
VSM2N60-T1	TO-251	VSM2N60-T1	50	
VSM2N60-T2	TO-252	VSM2N60-T2	50	
VSM2N60-TF	TO-220F	VSM2N60-TF		3000
VSM2N60-TC	TO-220C	VSM2N60-TC	72	

Electrical Characteristics
 $T_c = 25^\circ\text{C}$ unless otherwise noted

Parameter	Symbol	Test Condition	Min.	Typ.	Max.	Unit
Static characteristics						
Drain-source breakdown voltage	BV_{DSS}	$V_{GS}=0\text{ V}, I_D=0.25\text{ mA}$	600	-	-	V
Gate threshold voltage	$V_{GS(th)}$	$V_{DS}=V_{GS}, I_D=0.25\text{ mA}$	2	-	4	V
Drain cut-off current	I_{DSS}	$V_{DS}=600\text{ V}, V_{GS}=0\text{ V},$ $T_j = 25^\circ\text{C}$ $T_j = 125^\circ\text{C}$	-	-	1	μA
Gate leakage current, Forward	I_{GSSF}	$V_{GS}=30\text{ V}, V_{DS}=0\text{ V}$	-	-	100	nA
Gate leakage current, Reverse	I_{GSSR}	$V_{GS}=-30\text{ V}, V_{DS}=0\text{ V}$	-	-	-100	nA
Drain-source on-state resistance	$R_{DS(on)}$	$V_{GS}=10\text{ V}, I_D=1\text{ A}$	-	3.6	4.5	Ω
Dynamic characteristics						
Input capacitance	C_{iss}	$V_{DS} = 25\text{ V}, V_{GS} = 0\text{ V},$ $f = 1\text{ MHz}$	-	338	-	pF
Output capacitance	C_{oss}		-	36	-	
Reverse transfer capacitance	C_{rss}		-	3.4	-	
Turn-on delay time	$t_{d(on)}$	$V_{DD} = 300\text{ V}, I_D = 2\text{ A}$ $R_G = 10\ \Omega, V_{GS}=15\text{ V}$	-	16.8	-	ns
Rise time	t_r		-	35.5	-	
Turn-off delay time	$t_{d(off)}$		-	34.3	-	
Fall time	t_f		-	24.7	-	
Gate charge characteristics						
Gate to source charge	Q_{gs}	$V_{DD}=480\text{ V}, I_D=2\text{ A},$ $V_{GS}=0\text{ to }10\text{ V}$	-	2.6	-	nC
Gate to drain charge	Q_{gd}		-	4.7	-	
Gate charge total	Q_g		-	10.2	-	
Gate plateau voltage	$V_{plateau}$		-	5	-	V
Reverse diode characteristics						
Diode forward voltage	V_{SD}	$V_{GS}=0\text{ V}, I_F=2\text{ A}$	-	-	1.3	V
Reverse recovery time	t_{rr}	$V_R=400\text{ V}, I_F=2\text{ A},$ $di_F/dt=100\text{ A}/\mu\text{s}$	-	194	-	ns
Reverse recovery charge	Q_{rr}		-	0.7	-	μC
Peak reverse recovery current	I_{rrm}		-	7.4	-	A

Notes:

- Pulse width limited by maximum junction temperature.
- $L=10\text{mH}, I_{AS} = 4\text{ A},$ Starting $T_j= 25^\circ\text{C}.$
- $I_{SD} = 2\text{ A}, di/dt \leq 100\text{ A}/\mu\text{s}, V_{DD} \leq BV_{DS},$ Starting $T_j= 25^\circ\text{C}.$

Electrical Characteristics Diagrams

Figure 1. Typical Output Characteristics

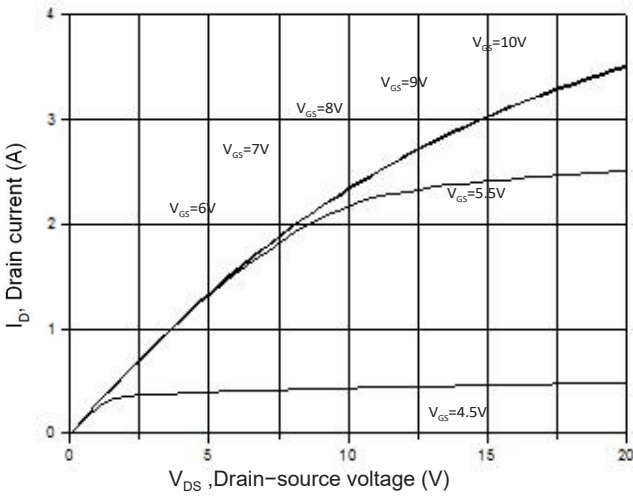

Figure 3. On-Resistance Variation vs. Drain Current

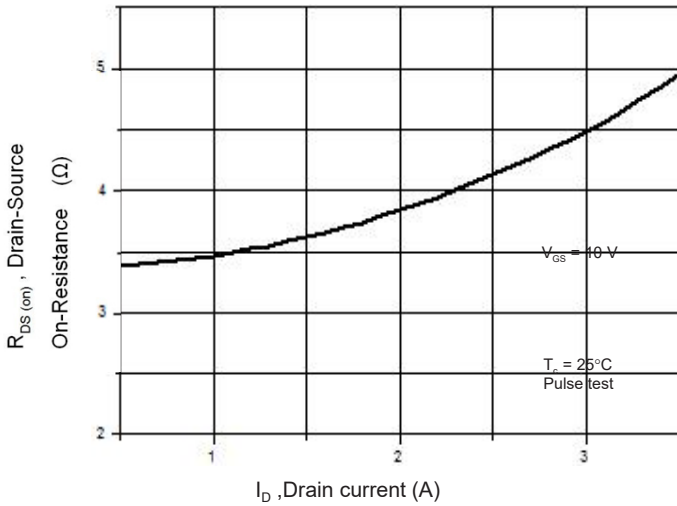

Figure 5. Breakdown Voltage vs. Temperature

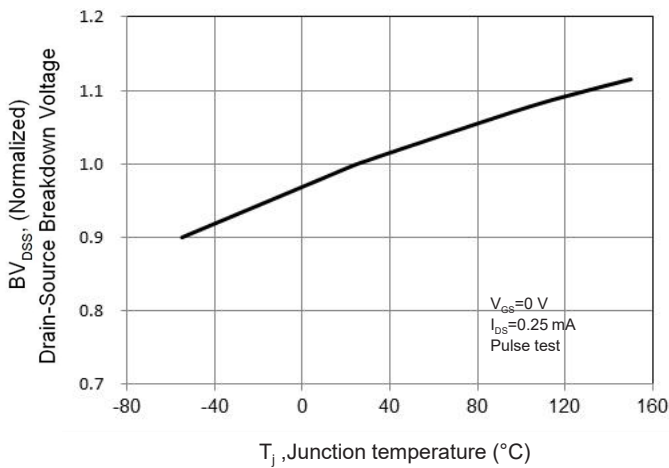

Figure 2. Transfer Characteristics

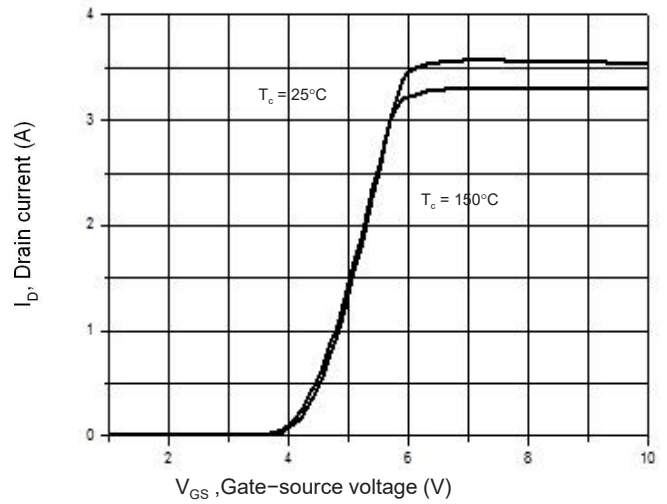

Figure 4. Threshold Voltage vs. Temperature

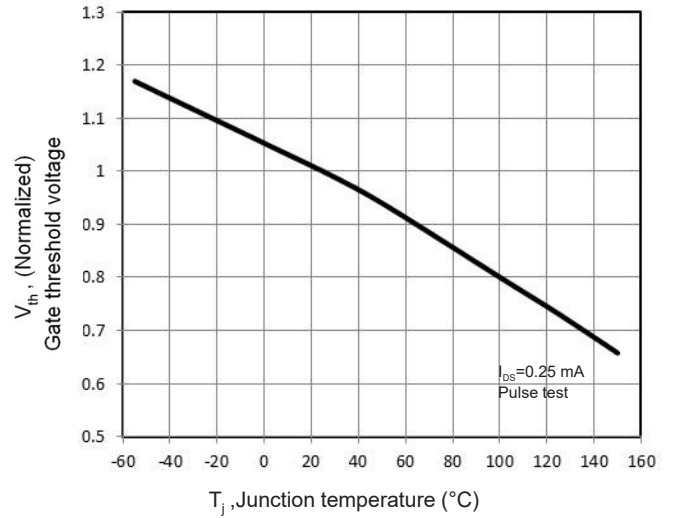

Figure 6. On-Resistance vs. Temperature

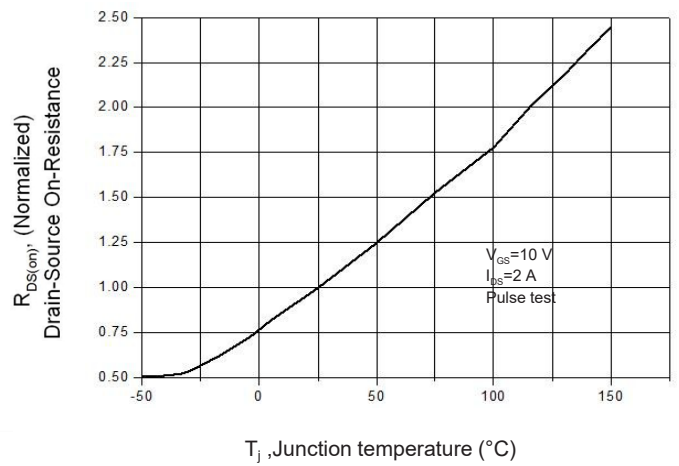

Figure 7. Capacitance Characteristics

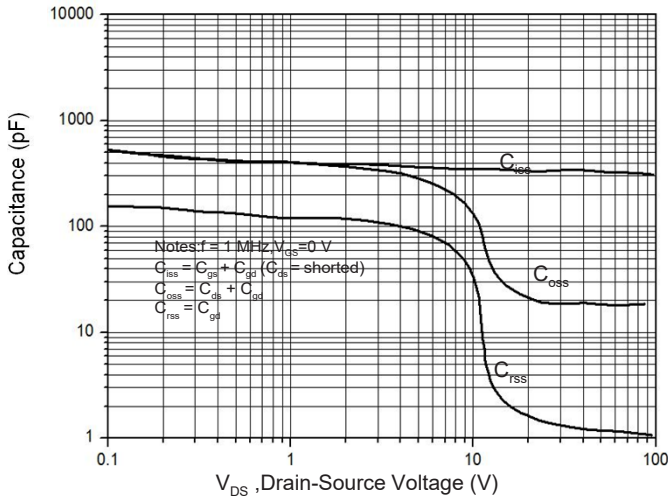

Figure 8. Gate Charge Characterist

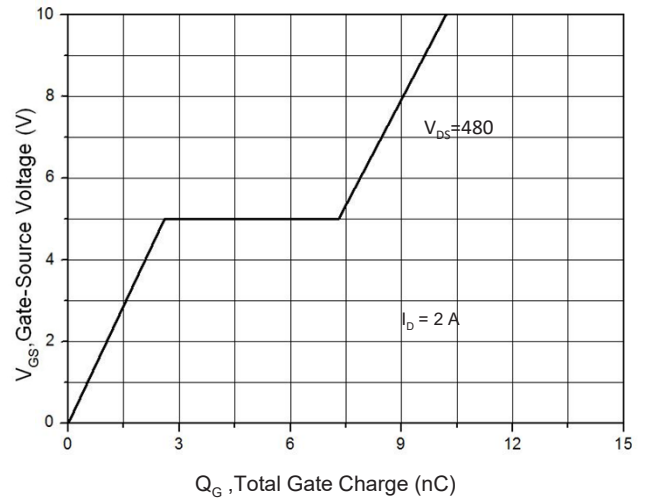
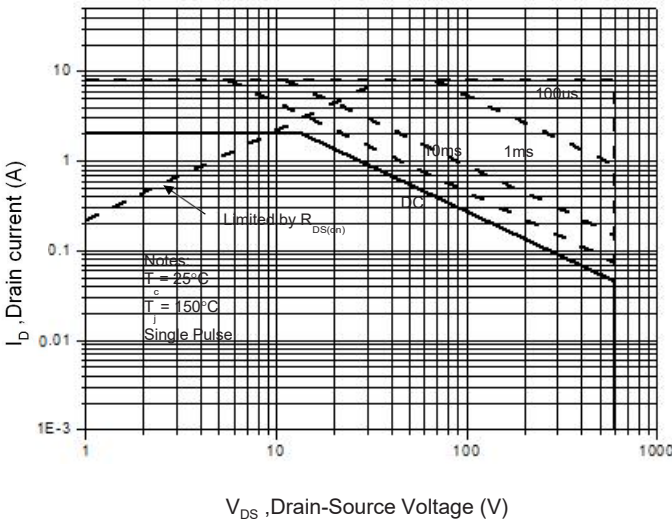
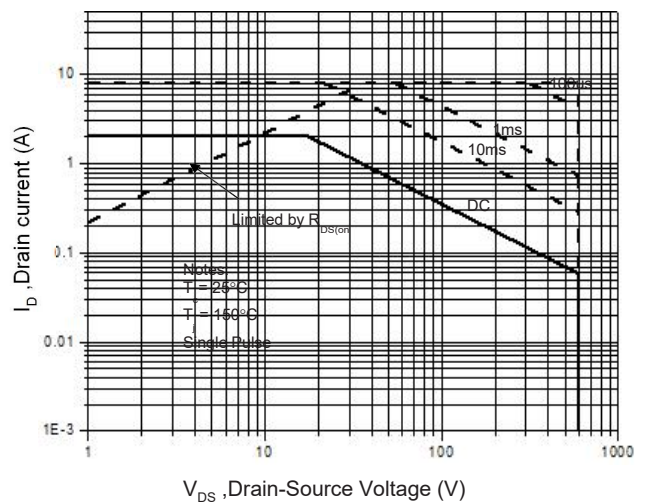
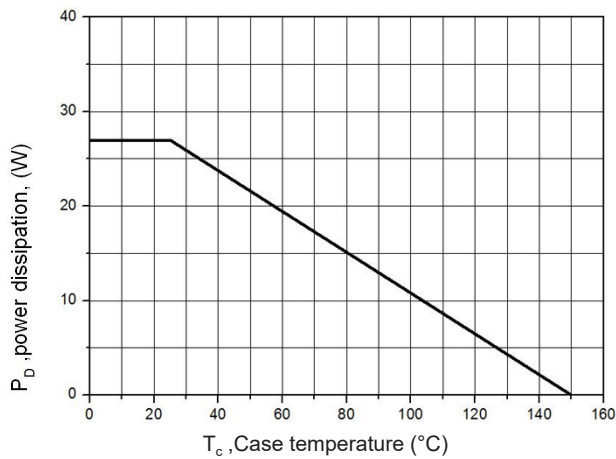
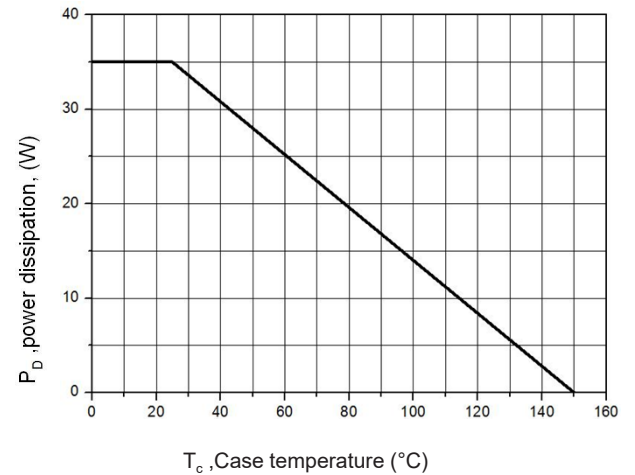

 Figure 9. Maximum Safe Operating Area
C C TO-220F

 Figure 10. Maximum Safe Operating Area
C C TO-220/TO-251/TO-252

 Figure 11. Power Dissipation vs. Temperature
C C TO-220F

 Figure 12. Power Dissipation vs. Temperature
C C TO-220/TO-251/TO-252

Figure 13. Continuous Drain Current vs. Temperature

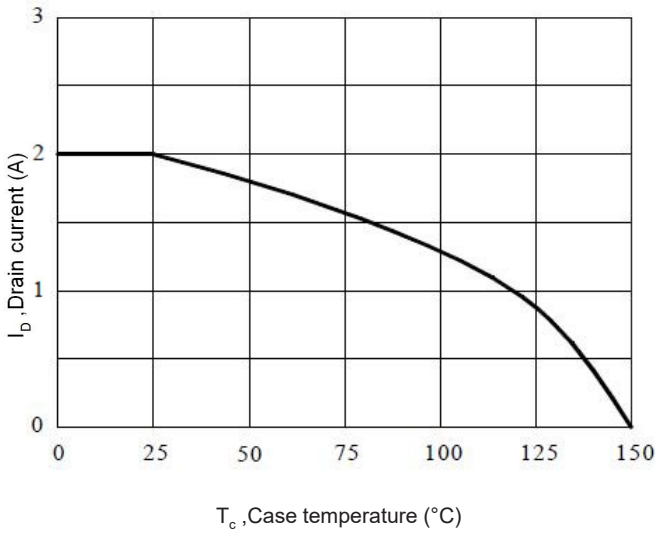
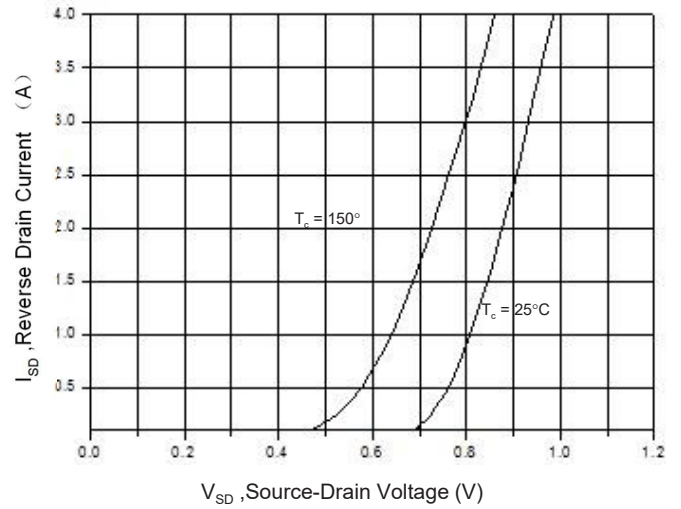
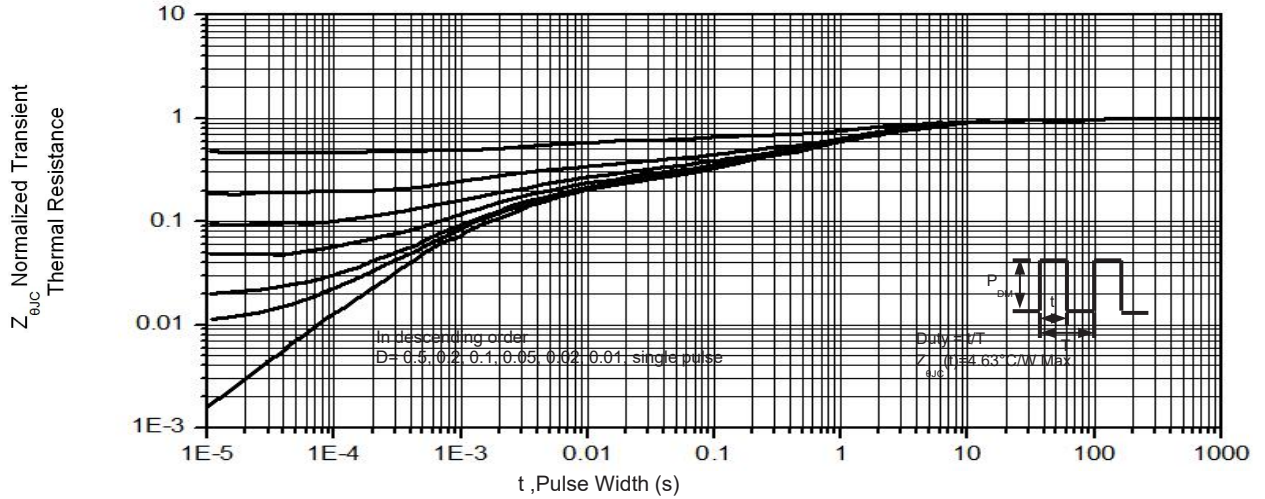
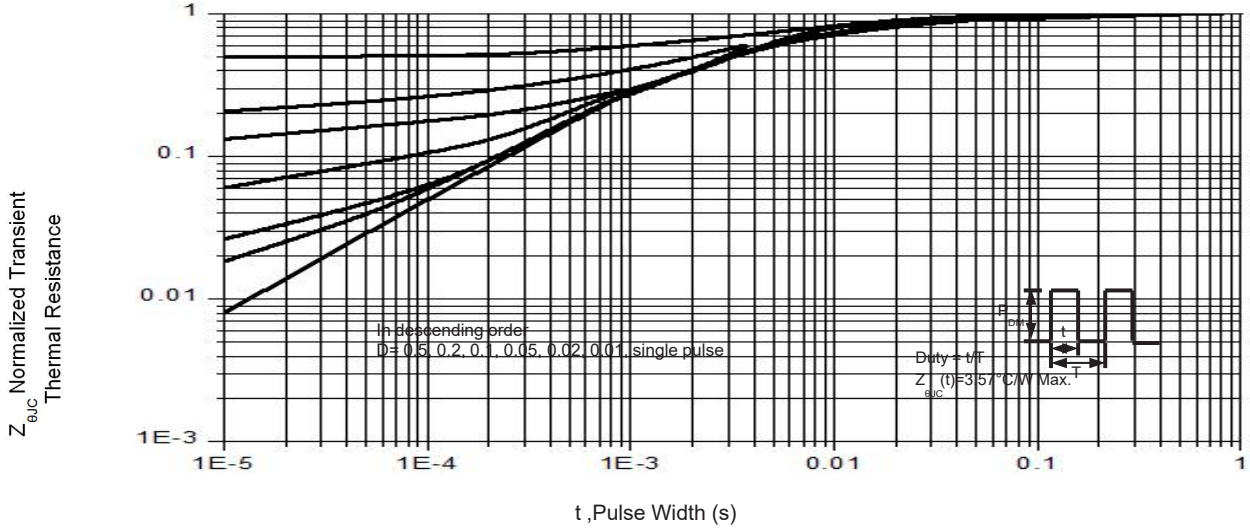
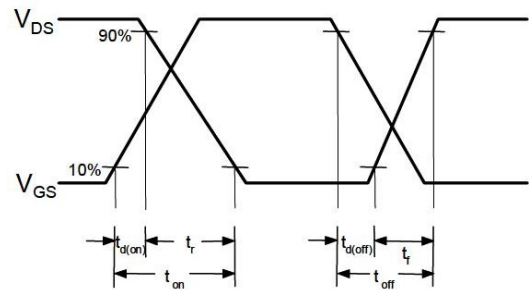
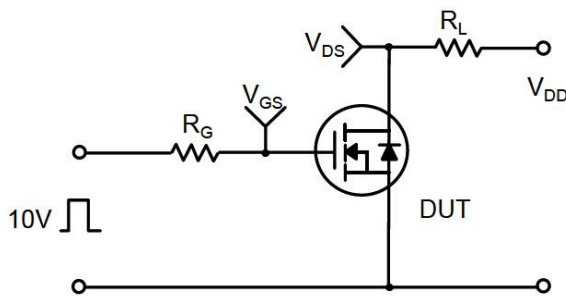
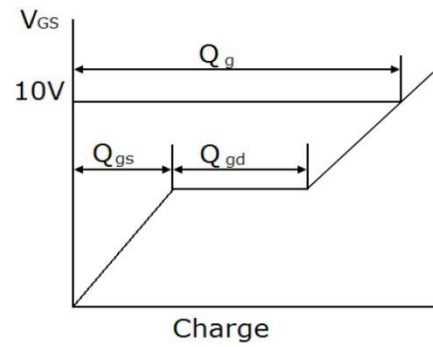
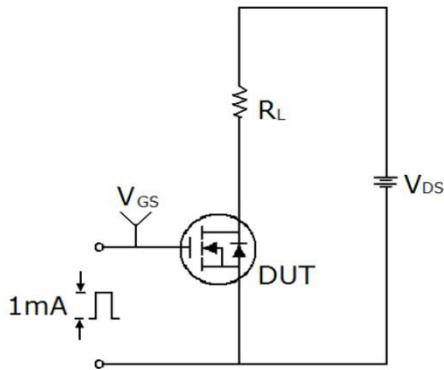

Figure 14. Body Diode Transfer Characteristics

 Figure 15 Transient Thermal Impedance, Junction to Case ζ TO-220F

 Figure 16. Transient Thermal Impedance, Junction to Case ζ TO-220/TO-251/TO-252

Gate Charge Test Circuit & Waveform

Unclamped Inductive Switching Test Circuit & Waveforms
