

Description

The VST04P056 uses **Super Trench** technology that is uniquely optimized to provide the most efficient high frequency switching performance. Both conduction and switching power losses are minimized due to an extremely low combination of $R_{DS(ON)}$ and Q_g . This device is ideal for high-frequency switching and synchronous rectification.

General Features

- $V_{DS} = -40V, I_D = -80A$
 $R_{DS(ON)} = 5.6m\Omega$ (typical) @ $V_{GS} = -10V$
 $R_{DS(ON)} = 7.6m\Omega$ (typical) @ $V_{GS} = -4.5V$
- Excellent gate charge x $R_{DS(on)}$ product(FOM)
- Very low on-resistance $R_{DS(on)}$
- 175 °C operating temperature
- Pb-free lead plating
- 100% UIS tested

Application

- DC/DC Converter
- Ideal for high-frequency switching and synchronous rectification



TO-263

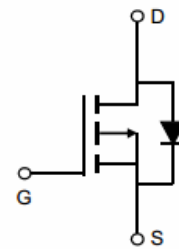

Schematic Diagram

Package Marking and Ordering Information

Device Marking	Device	Device Package	Reel Size	Tape width	Quantity
VST04P056-T3	VST04P056	TO-263	-	-	-

Absolute Maximum Ratings ($T_C = 25^\circ C$ unless otherwise noted)

Parameter	Symbol	Limit	Unit
Drain-Source Voltage	V_{DS}	-40	V
Gate-Source Voltage	V_{GS}	± 20	V
Drain Current-Continuous	I_D	-80	A
Drain Current-Continuous($T_C = 100^\circ C$)	$I_D(100^\circ C)$	-56.5	A
Pulsed Drain Current	I_{DM}	-320	A
Maximum Power Dissipation	P_D	150	W
Derating factor		1	W/ $^\circ C$
Single pulse avalanche energy ^(Note 5)	E_{AS}	500	mJ
Operating Junction and Storage Temperature Range	T_J, T_{STG}	-55 To 175	$^\circ C$

Thermal Characteristic

Thermal Resistance, Junction-to-Case ^(Note 2)	$R_{\theta JC}$	1.0	$^{\circ}\text{C}/\text{W}$
--	-----------------	-----	-----------------------------

Electrical Characteristics ($T_C=25^{\circ}\text{C}$ unless otherwise noted)

Parameter	Symbol	Condition	Min	Typ	Max	Unit
Off Characteristics						
Drain-Source Breakdown Voltage	BV_{DSS}	$V_{GS}=0V, I_D=-250\mu A$	-40		-	V
Zero Gate Voltage Drain Current	I_{DSS}	$V_{DS}=-40V, V_{GS}=0V$	-	-	1	μA
Gate-Body Leakage Current	I_{GSS}	$V_{GS}=\pm 20V, V_{DS}=0V$	-	-	± 100	nA
On Characteristics ^(Note 3)						
Gate Threshold Voltage	$V_{GS(th)}$	$V_{DS}=V_{GS}, I_D=-250\mu A$	-0.8	-1.2	-1.8	V
Drain-Source On-State Resistance	$R_{DS(on)}$	$V_{GS}=-10V, I_D=-40A$	-	5.6	6.2	m Ω
		$V_{GS}=-4.5V, I_D=-40A$	-	7.6	9.1	m Ω
Forward Transconductance	g_{FS}	$V_{DS}=-5V, I_D=-40A$	-	30	-	S
Dynamic Characteristics ^(Note 4)						
Input Capacitance	C_{iss}	$V_{DS}=-20V, V_{GS}=0V,$ $F=1.0\text{MHz}$	-	3738	-	PF
Output Capacitance	C_{oss}		-	882	-	PF
Reverse Transfer Capacitance	C_{rss}		-	22	-	PF
Switching Characteristics ^(Note 4)						
Turn-on Delay Time	$t_{d(on)}$	$V_{DD}=-20V, I_D=-40A$ $V_{GS}=-10V, R_G=1.6\Omega$	-	10.5	-	nS
Turn-on Rise Time	t_r		-	4	-	nS
Turn-Off Delay Time	$t_{d(off)}$		-	35	-	nS
Turn-Off Fall Time	t_f		-	5	-	nS
Total Gate Charge	Q_g	$V_{DS}=-20V, I_D=-40A,$ $V_{GS}=-10V$	-	57.2	-	nC
Gate-Source Charge	Q_{gs}		-	9.8	-	nC
Gate-Drain Charge	Q_{gd}		-	7.3	-	nC
Drain-Source Diode Characteristics						
Diode Forward Voltage ^(Note 3)	V_{SD}	$V_{GS}=0V, I_S=-40A$	-		-1.2	V
Diode Forward Current ^(Note 2)	I_S		-	-	-80	A
Reverse Recovery Time	t_{rr}	$T_J = 25^{\circ}\text{C}, I_F = -40A$ $di/dt = 100A/\mu s$ ^(Note 3)	-		24	nS
Reverse Recovery Charge	Q_{rr}		-		68	nC

Notes:

1. Repetitive Rating: Pulse width limited by maximum junction temperature.
2. Surface Mounted on FR4 Board, $t \leq 10$ sec.
3. Pulse Test: Pulse Width $\leq 300\mu s$, Duty Cycle $\leq 2\%$.
4. Guaranteed by design, not subject to production
5. EAS condition : $T_J=25^{\circ}\text{C}, V_{DD}=-20V, V_G=-10V, L=0.5\text{mH}, R_g=25\Omega$

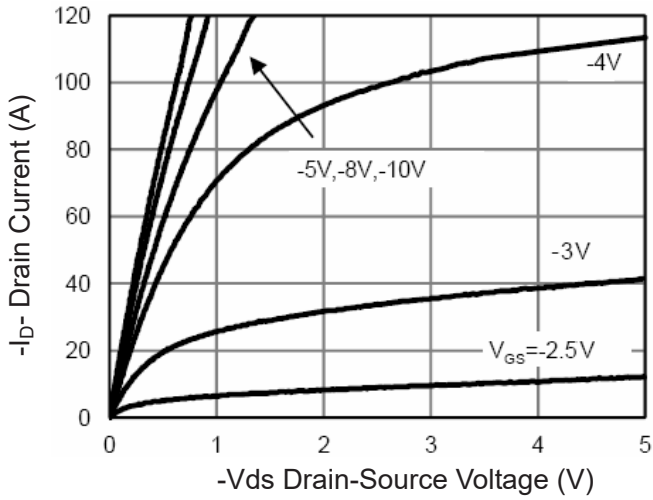
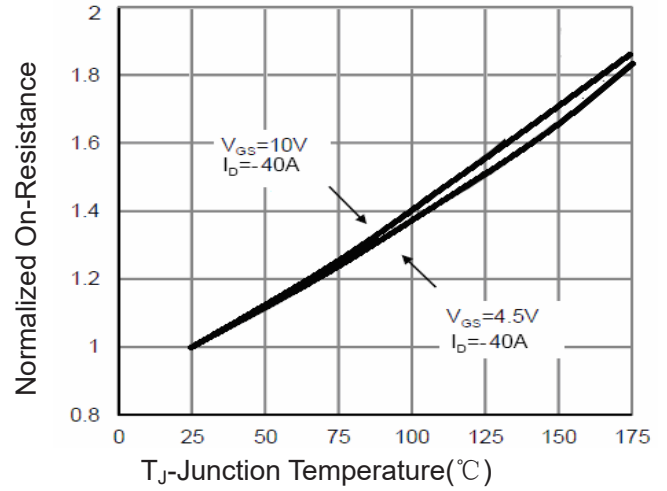
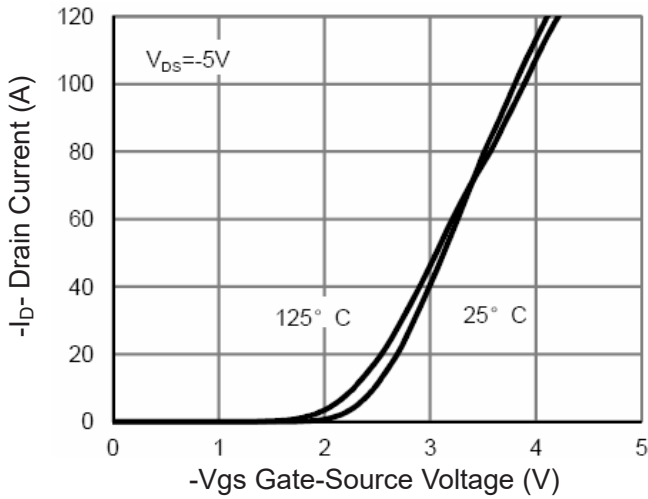
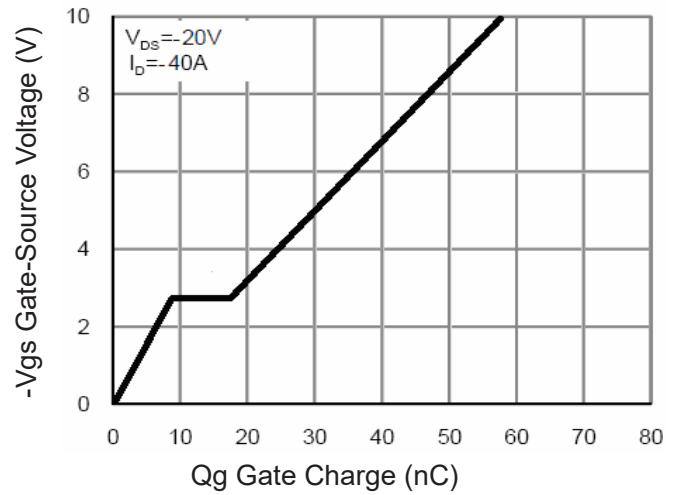
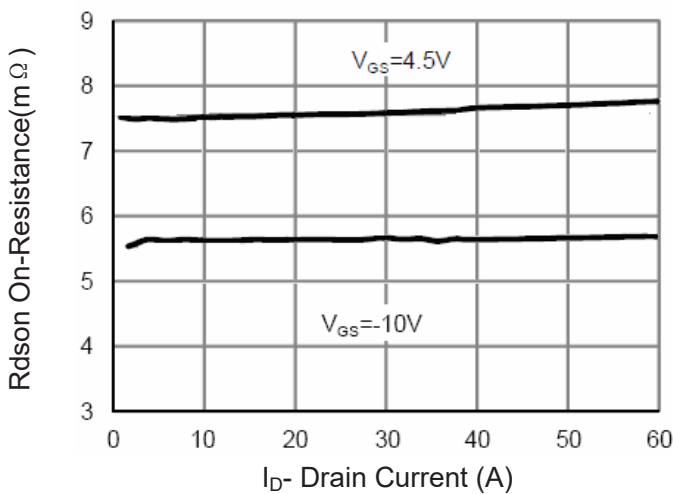
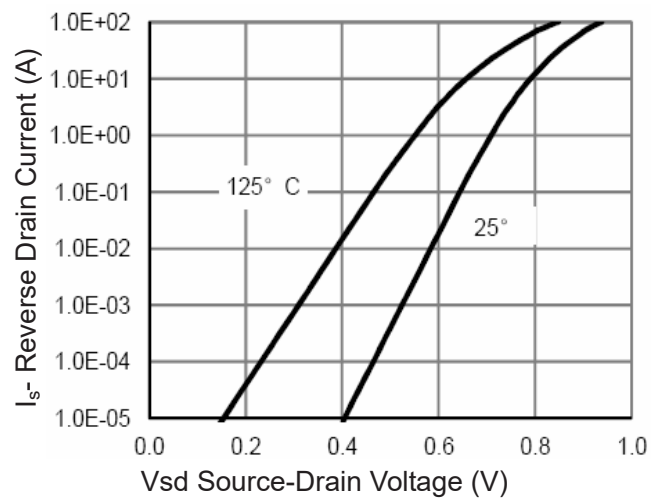
Typical Electrical and Thermal Characteristics

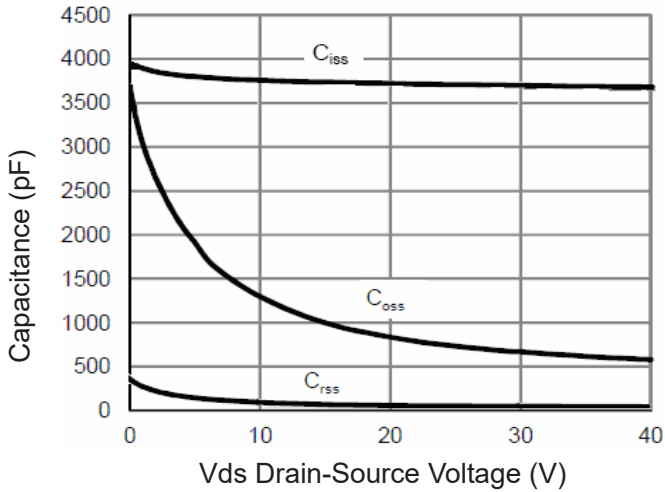
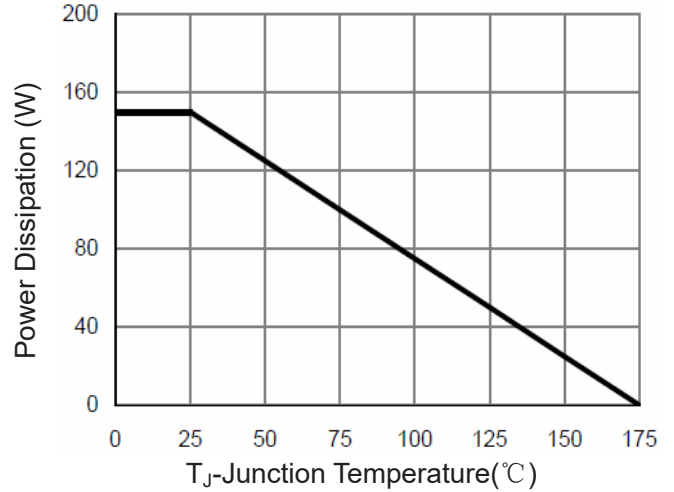
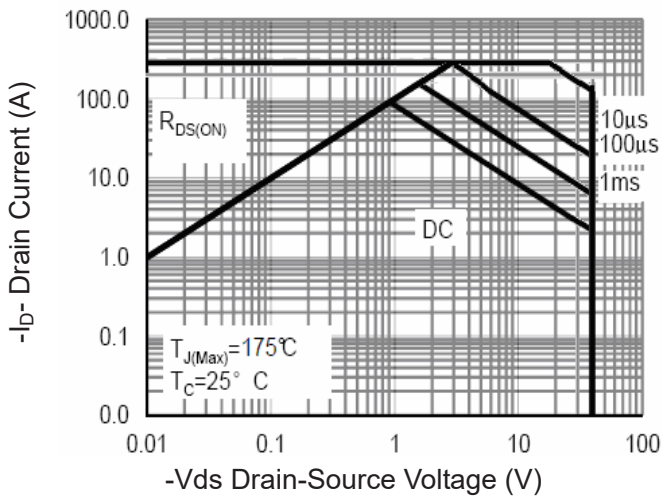
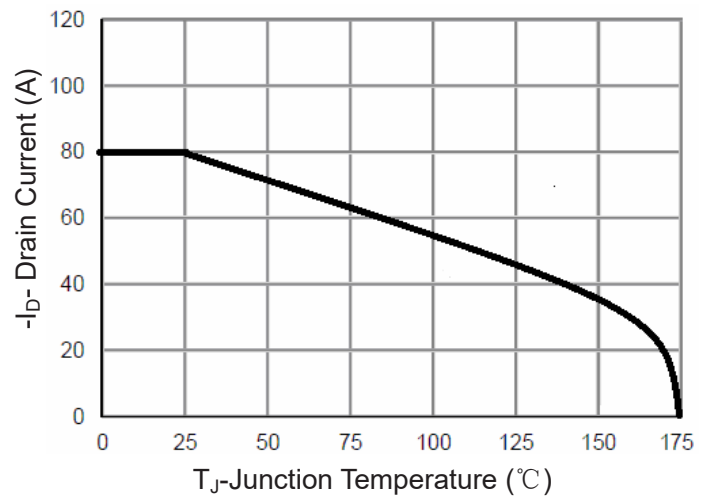
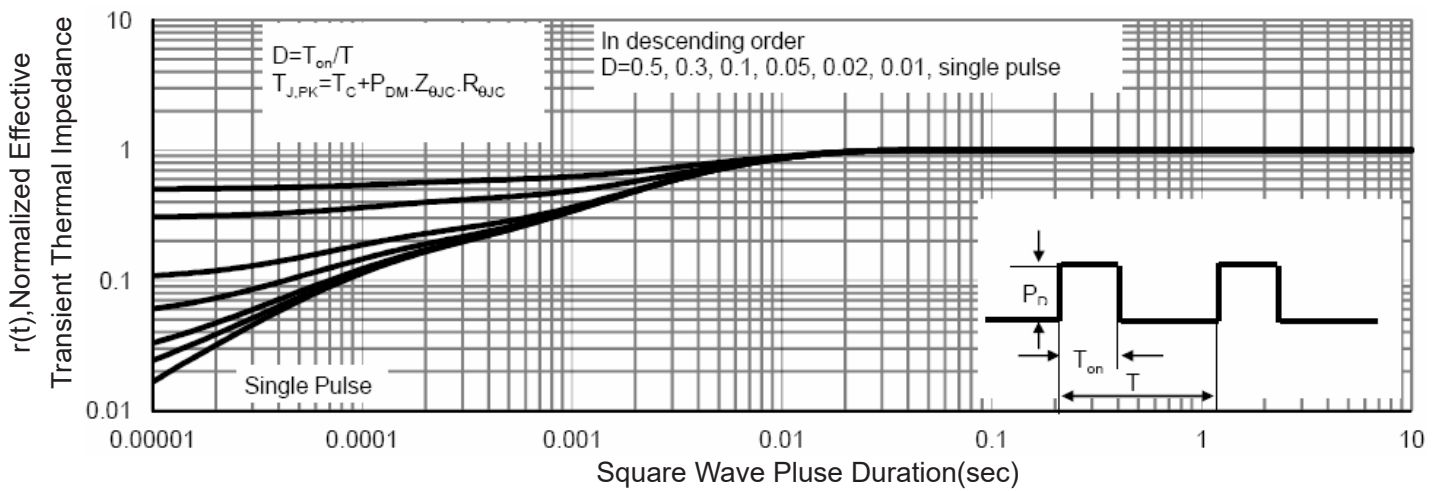
Figure 1 Output Characteristics

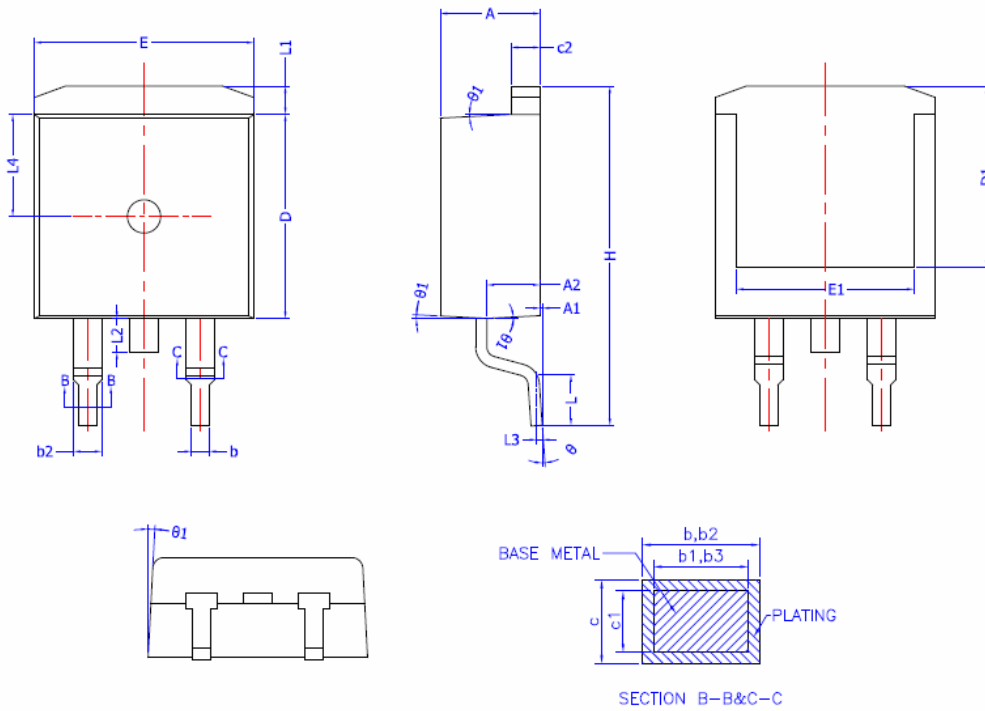
Figure 4 Rds(on)-Junction Temperature

Figure 2 Transfer Characteristics

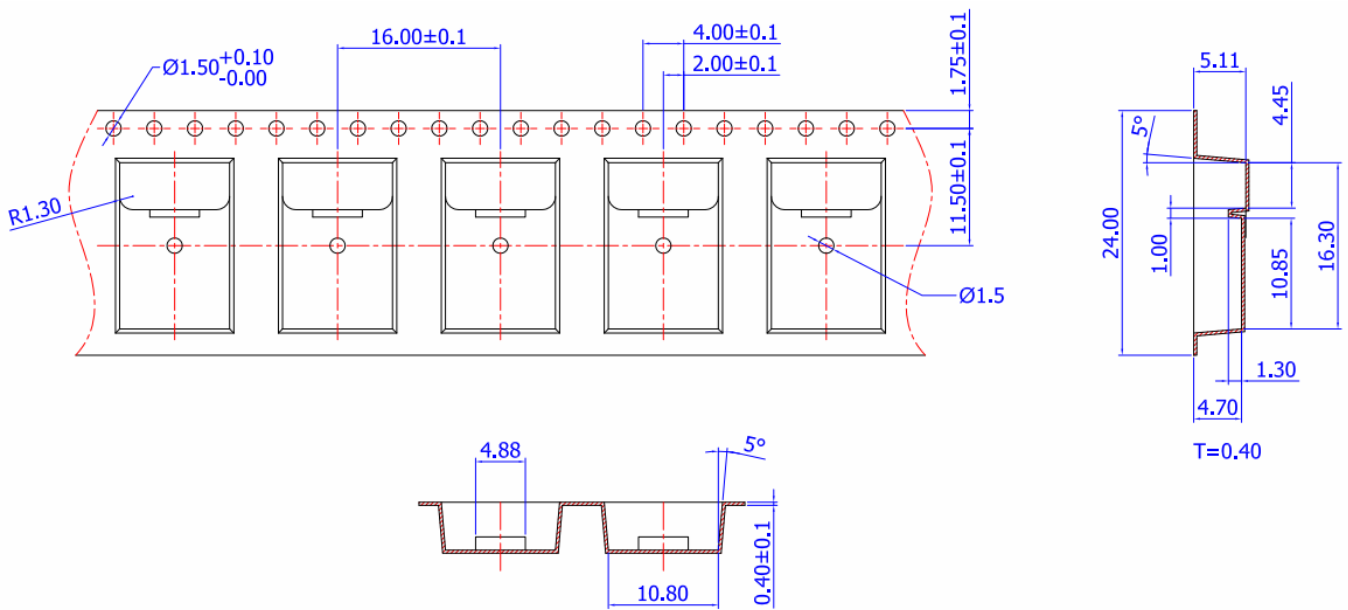
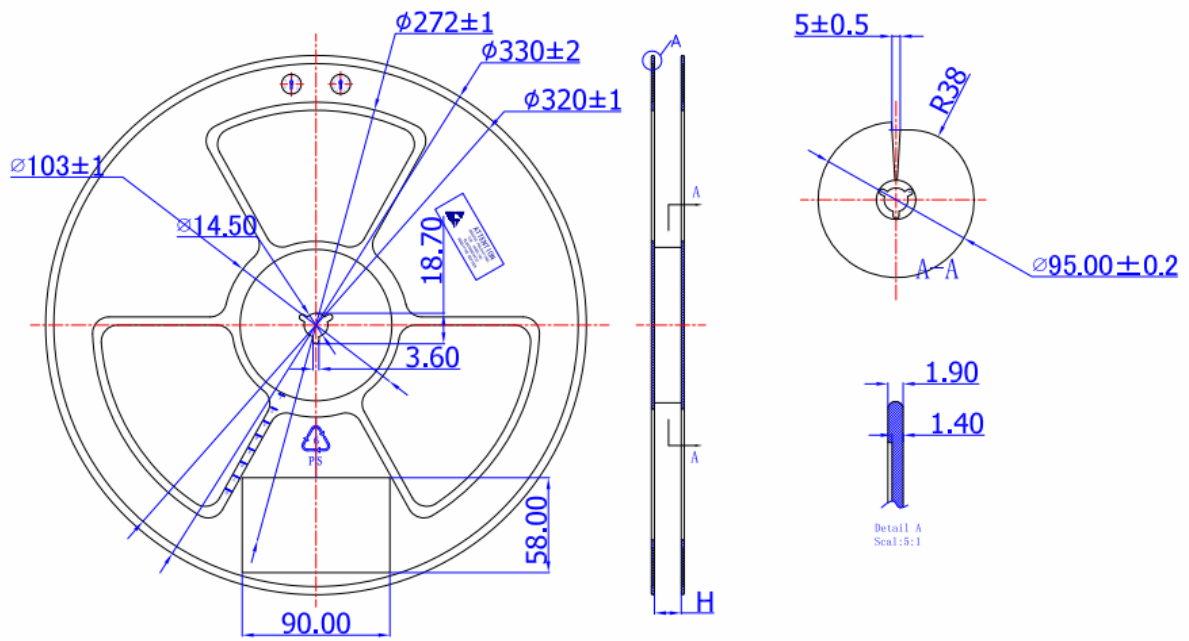
Figure 5 Gate Charge

Figure 3 Rds(on)- Drain Current

Figure 6 Source- Drain Diode Forward

Figure 7 Capacitance vs Vds

Figure 9 Power De-rating

Figure 8 Safe Operation Area

Figure 10 Current De-rating

Figure 11 Normalized Maximum Transient Thermal Impedance

TO-263-2L Package Information

**COMMON DIMENSIONS
(UNITS OF MEASURE =MILLIMETER)**

SYMBOL	MIN	NOM	MAX
A	4.40	4.50	4.60
A1	0	0.10	0.25
A2	2.20	2.40	2.60
b	0.76	—	0.89
b1	0.75	0.80	0.85
b2	1.23	—	1.37
b3	1.22	1.27	1.32
c	0.47	—	0.60
c1	0.46	0.51	0.56
c2	1.25	1.30	1.35
D	9.10	9.20	9.30
D1	8.00	—	—
E	9.80	9.90	10.00
E1	7.80	—	—
e	2.54 BSC		
H	14.90	15.30	15.70
L	2.00	2.30	2.60
L1	1.17	1.27	1.40
L2	—	—	1.75
L3	0.25BSC		
L4	4.60 REF		
θ	0°	—	8°
θ1	1°	3°	5°



注：产品编入卷盘中时，产品第一支脚(PIN 1)方向朝向载带传送孔。如下图所示。

