

Description

The VST08N050 uses **Super Trench** technology that is uniquely optimized to provide the most efficient high frequency switching performance. Both conduction and switching power losses are minimized due to an extremely low combination of $R_{DS(ON)}$ and Q_g . This device is ideal for high-frequency switching and synchronous rectification.

General Features

- $V_{DS} = 85V, I_D = 115A$
 $R_{DS(ON)} < 5.7m\Omega @ V_{GS} = 10V$
- Excellent gate charge x $R_{DS(on)}$ product(FOM)
- Very low on-resistance $R_{DS(on)}$
- 175 °C operating temperature
- Pb-free lead plating
- 100% UIS tested

Application

- DC/DC Converter
- Ideal for high-frequency switching and synchronous rectification



TO-220C

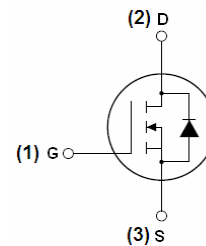

Schematic Diagram

Package Marking and Ordering Information

| Device Marking | Device | Device Package | Reel Size | Tape width | Quantity |
|----------------|-----------|----------------|-----------|------------|----------|
| VST08N050-TC | VST08N050 | TO-220C | - | - | - |

Absolute Maximum Ratings ($T_C = 25^\circ C$ unless otherwise noted)

| Parameter | Symbol | Limit | Unit |
|---|--------------------|------------|---------------|
| Drain-Source Voltage | V_{DS} | 85 | V |
| Gate-Source Voltage | V_{GS} | ± 20 | V |
| Drain Current-Continuous | I_D | 115 | A |
| Drain Current-Continuous($T_C = 100^\circ C$) | $I_D(100^\circ C)$ | 81.3 | A |
| Pulsed Drain Current | I_{DM} | 420 | A |
| Maximum Power Dissipation | P_D | 157 | W |
| Derating factor | | 1.05 | W/ $^\circ C$ |
| Single pulse avalanche energy ^(Note 5) | E_{AS} | 726 | mJ |
| Operating Junction and Storage Temperature Range | T_J, T_{STG} | -55 To 175 | $^\circ C$ |

Thermal Characteristic

| | | | |
|--|-----------------|------|-----------------------------|
| Thermal Resistance, Junction-to-Case ^(Note 2) | $R_{\theta JC}$ | 0.96 | $^{\circ}\text{C}/\text{W}$ |
|--|-----------------|------|-----------------------------|

Electrical Characteristics ($T_C=25^{\circ}\text{C}$ unless otherwise noted)

| Parameter | Symbol | Condition | Min | Typ | Max | Unit |
|--|--------------|--|-----|-------|-----------|------------|
| Off Characteristics | | | | | | |
| Drain-Source Breakdown Voltage | BV_{DSS} | $V_{GS}=0V, I_D=250\mu A$ | 85 | | - | V |
| Zero Gate Voltage Drain Current | I_{DSS} | $V_{DS}=85V, V_{GS}=0V$ | - | - | 1 | μA |
| Gate-Body Leakage Current | I_{GSS} | $V_{GS}=\pm 20V, V_{DS}=0V$ | - | - | ± 100 | nA |
| On Characteristics ^(Note 3) | | | | | | |
| Gate Threshold Voltage | $V_{GS(th)}$ | $V_{DS}=V_{GS}, I_D=250\mu A$ | 2.0 | 2.9 | 4.0 | V |
| Drain-Source On-State Resistance | $R_{DS(ON)}$ | $V_{GS}=10V, I_D=55A$ | - | 5.0 | 5.7 | m Ω |
| Forward Transconductance | g_{FS} | $V_{DS}=10V, I_D=55A$ | - | 47 | - | S |
| Dynamic Characteristics ^(Note 4) | | | | | | |
| Input Capacitance | C_{iss} | $V_{DS}=40V, V_{GS}=0V,$ $F=1.0\text{MHz}$ | - | 3841 | - | PF |
| Output Capacitance | C_{oss} | | - | 651.7 | - | PF |
| Reverse Transfer Capacitance | C_{rss} | | - | 32.7 | - | PF |
| Switching Characteristics ^(Note 4) | | | | | | |
| Turn-on Delay Time | $t_{d(on)}$ | $V_{DD}=40V, I_D=55A$ $V_{GS}=10V, R_G=3\Omega$ | - | 15.6 | - | nS |
| Turn-on Rise Time | t_r | | - | 32.7 | - | nS |
| Turn-Off Delay Time | $t_{d(off)}$ | | - | 24.2 | - | nS |
| Turn-Off Fall Time | t_f | | - | 15.1 | - | nS |
| Total Gate Charge | Q_g | $V_{DS}=40V, I_D=55A,$ $V_{GS}=10V$ | - | 59.4 | | nC |
| Gate-Source Charge | Q_{gs} | | - | 16.5 | | nC |
| Gate-Drain Charge | Q_{gd} | | - | 12.3 | | nC |
| Drain-Source Diode Characteristics | | | | | | |
| Diode Forward Voltage ^(Note 3) | V_{SD} | $V_{GS}=0V, I_S=115A$ | - | | 1.2 | V |
| Diode Forward Current ^(Note 2) | I_S | | - | - | 115 | A |
| Reverse Recovery Time | t_{rr} | $T_J = 25^{\circ}\text{C}, I_F = 55$ $di/dt = 100A/\mu\text{s}$ ^(Note 3) | - | 64.3 | | nS |
| Reverse Recovery Charge | Q_{rr} | | - | 152.7 | | nC |

Notes:

1. Repetitive Rating: Pulse width limited by maximum junction temperature.
2. Surface Mounted on FR4 Board, $t \leq 10$ sec.
3. Pulse Test: Pulse Width $\leq 300\mu\text{s}$, Duty Cycle $\leq 2\%$.
4. Guaranteed by design, not subject to production
5. EAS condition : $T_J=25^{\circ}\text{C}, V_{DD}=42.5V, V_G=10V, L=0.5\text{mH}, R_G=25\Omega$

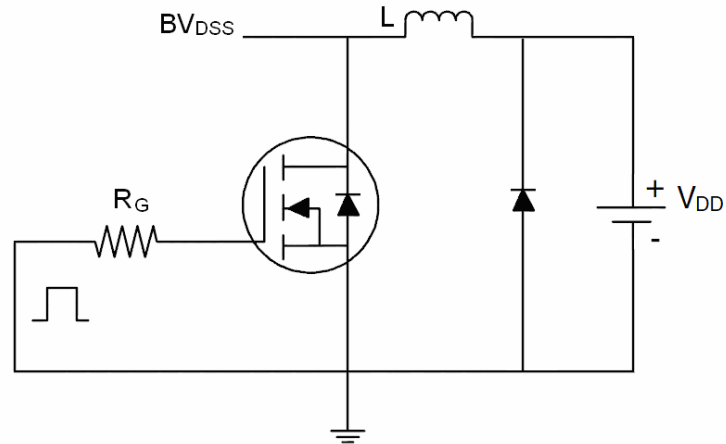
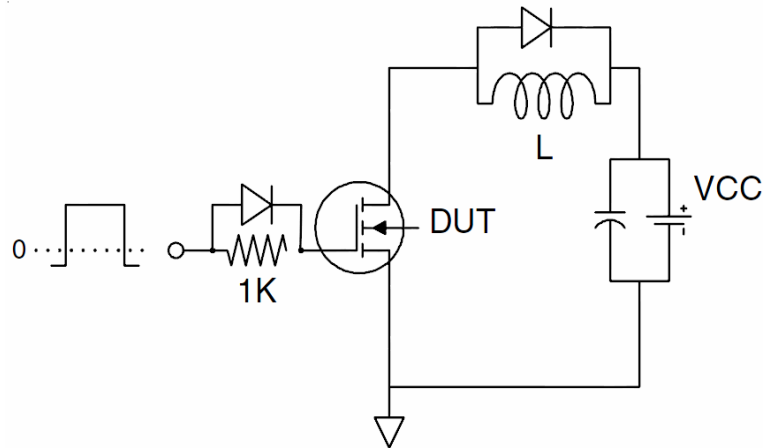
Test Circuit
1) E_{AS} test Circuit

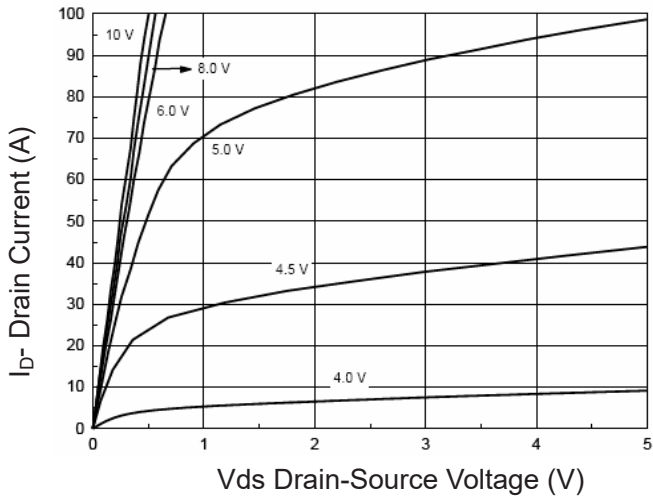
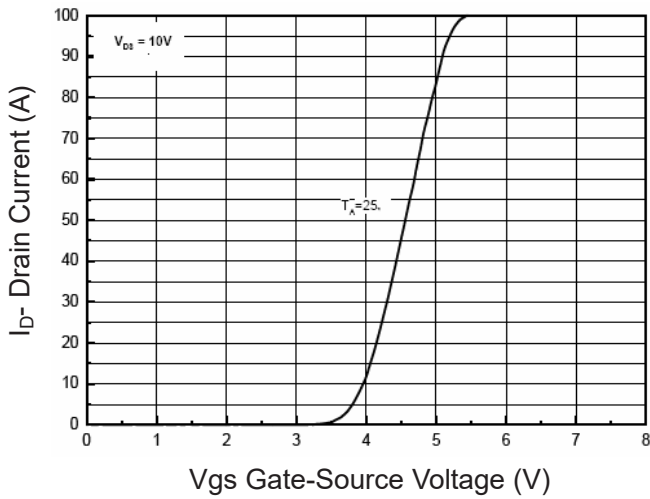
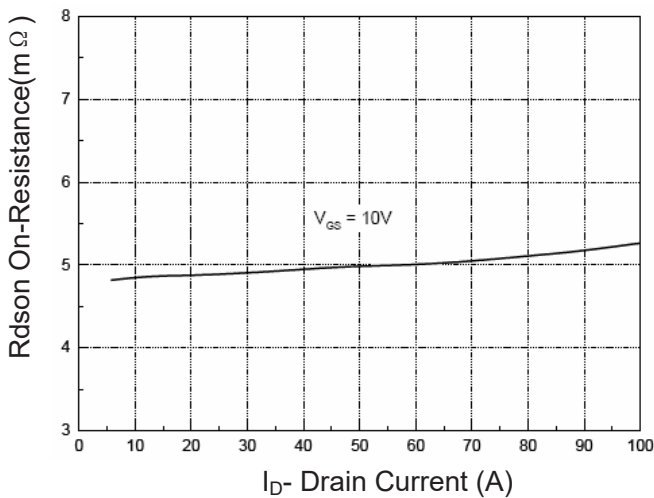
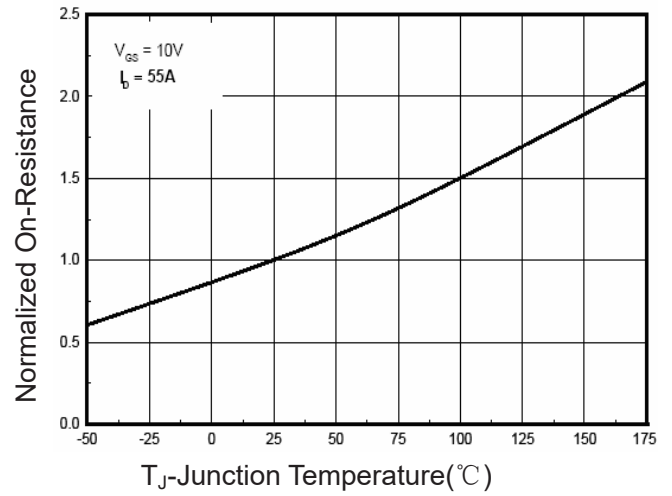
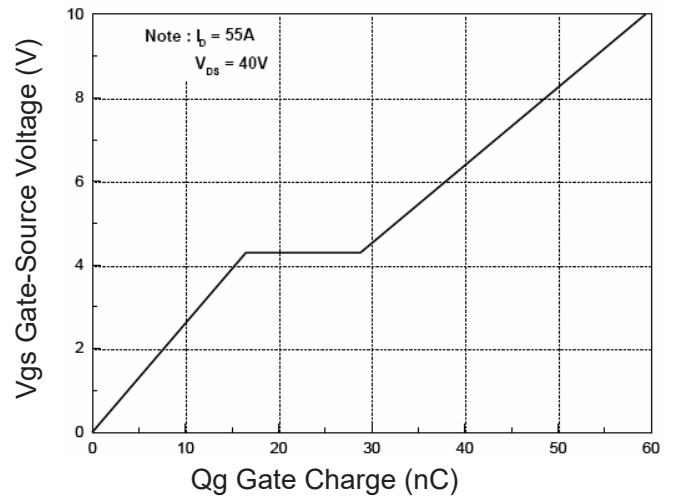
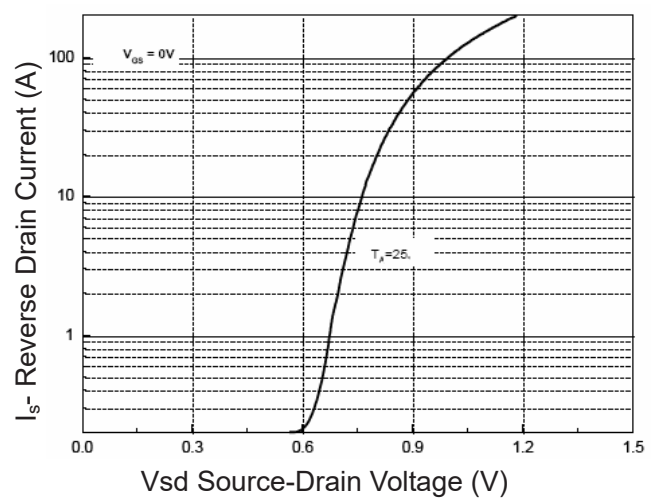
2) Gate charge test Circuit

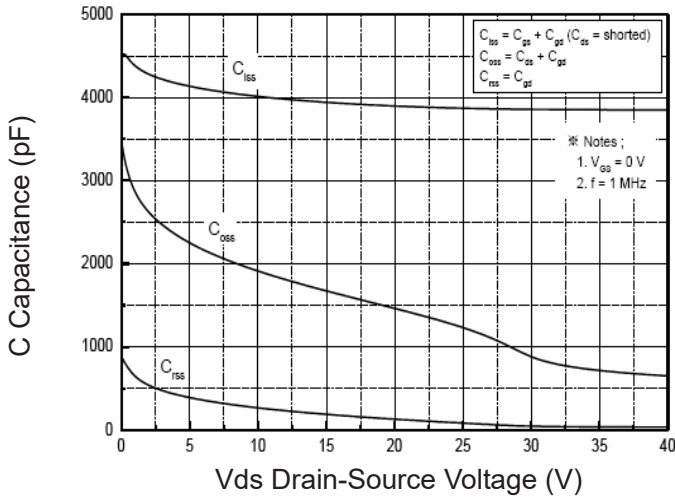
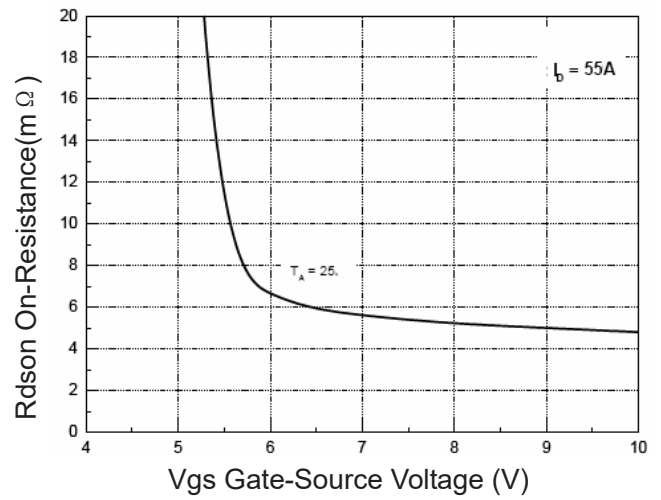
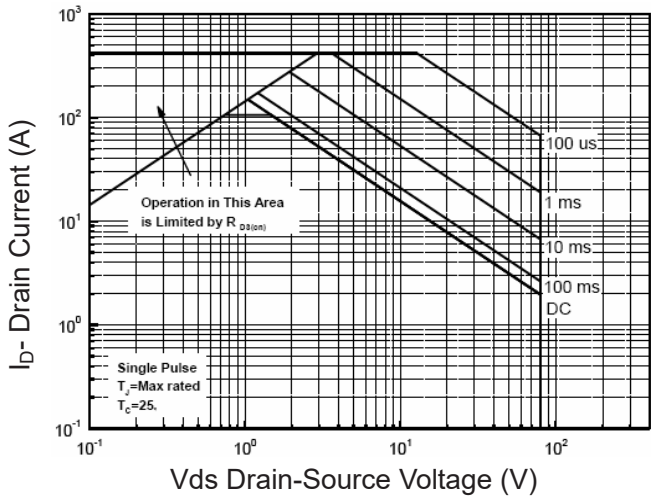
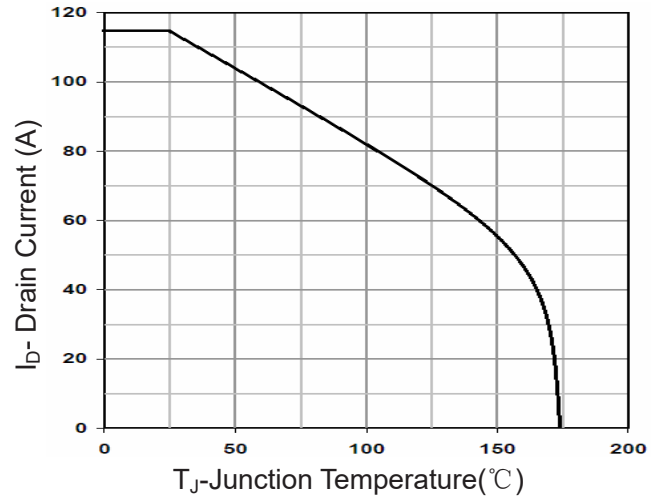
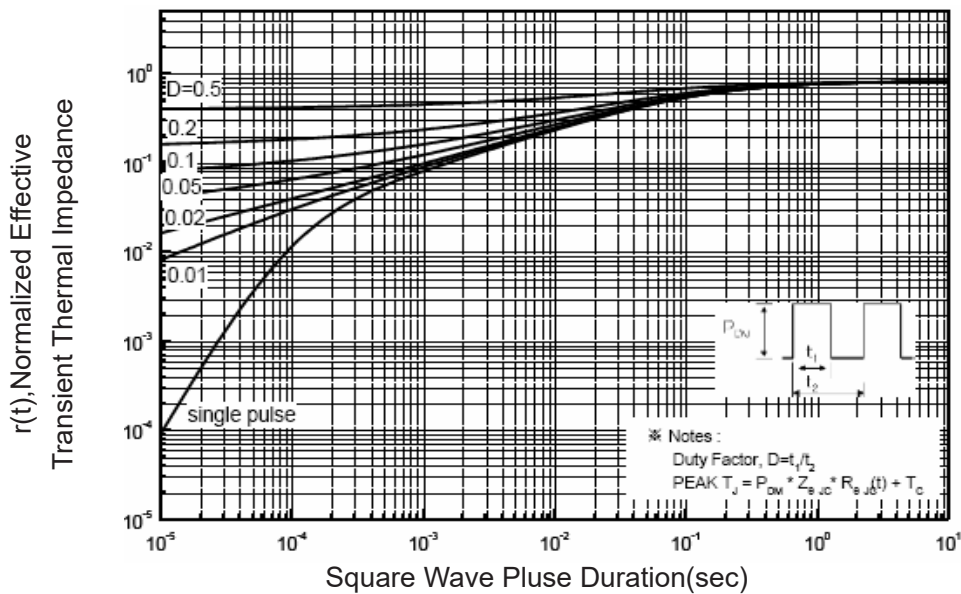
3) Switch Time Test Circuit

Typical Electrical and Thermal Characteristics

Figure 1 Output Characteristics

Figure 2 Transfer Characteristics

Figure 3 Rdson- Drain Current

Figure 4 Rdson-Junction Temperature

Figure 5 Gate Charge

Figure 6 Source- Drain Diode Forward

Figure 7 Capacitance vs Vds

Figure 9 Rdson vs Vgs

Figure 8 Safe Operation Area

Figure 10 Current De-rating

Figure 11 Normalized Maximum Transient Thermal Impedance