

### Description

The VST25N600 uses **Super Trench** technology that is uniquely optimized to provide the most efficient high frequency switching performance. Both conduction and switching power losses are minimized due to an extremely low combination of  $R_{DS(on)}$  and  $Q_g$ . This device is ideal for high-frequency switching and synchronous rectification.

### General Features

- $V_{DS} = 250V, I_D = 25A$   
 $R_{DS(on)} = 60m\Omega$  (typical) @  $V_{GS} = 10V$
- Excellent gate charge x  $R_{DS(on)}$  product(FOM)
- Very low on-resistance  $R_{DS(on)}$
- 175 °C operating temperature
- Pb-free lead plating
- 100% UIS tested

### Application

- LED backlighting
- Ideal for high-frequency switching and synchronous rectification



TO-252

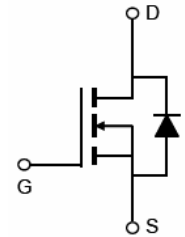

Schematic Diagram

### Package Marking and Ordering Information

Device Marking	Device	Device Package	Reel Size	Tape width	Quantity
VST25N600-T2	VST25N600	TO-252	Ø330mm	12mm	2500 units

### Absolute Maximum Ratings ( $T_A = 25^\circ\text{C}$ unless otherwise noted)

Parameter	Symbol	Limit	Unit
Drain-Source Voltage	$V_{DS}$	250	V
Gate-Source Voltage	$V_{GS}$	$\pm 20$	V
Drain Current-Continuous	$I_D$	25	A
Drain Current-Continuous( $T_C = 100^\circ\text{C}$ )	$I_D(100^\circ\text{C})$	17.5	A
Pulsed Drain Current	$I_{DM}$	100	A
Maximum Power Dissipation	$P_D$	135	W
Derating factor		0.9	W/ $^\circ\text{C}$
Single pulse avalanche energy <sup>(Note 5)</sup>	$E_{AS}$	320	mJ
Operating Junction and Storage Temperature Range	$T_J, T_{STG}$	-55 To 175	$^\circ\text{C}$

### Thermal Characteristic

Thermal Resistance, Junction-to-Case <sup>(Note 2)</sup>	$R_{\theta JC}$	1.11	$^\circ\text{C}/\text{W}$
--	-----------------	------	---------------------------

**Electrical Characteristics ( $T_A=25^{\circ}\text{C}$  unless otherwise noted)**

Parameter	Symbol	Condition	Min	Typ	Max	Unit
<b>Off Characteristics</b>						
Drain-Source Breakdown Voltage	$BV_{DSS}$	$V_{GS}=0V, I_D=250\mu A$	250	-	-	V
Zero Gate Voltage Drain Current	$I_{DSS}$	$V_{DS}=250V, V_{GS}=0V$	-	-	1	$\mu A$
Gate-Body Leakage Current	$I_{GSS}$	$V_{GS}=\pm 20V, V_{DS}=0V$	-	-	$\pm 100$	nA
<b>On Characteristics</b> (Note 3)						
Gate Threshold Voltage	$V_{GS(th)}$	$V_{DS}=V_{GS}, I_D=250\mu A$	2.5	3.5	4.5	V
Drain-Source On-State Resistance	$R_{DS(ON)}$	$V_{GS}=10V, I_D=20A$	-	60	70	m $\Omega$
Forward Transconductance	$g_{FS}$	$V_{DS}=5V, I_D=20A$	15	-	-	S
<b>Dynamic Characteristics</b> (Note 4)						
Input Capacitance	$C_{ISS}$	$V_{DS}=125V, V_{GS}=0V,$ $F=1.0\text{MHz}$	-	1600		PF
Output Capacitance	$C_{OSS}$		-	92		PF
Reverse Transfer Capacitance	$C_{RSS}$		-	4.3		PF
<b>Switching Characteristics</b> (Note 4)						
Turn-on Delay Time	$t_{d(on)}$	$V_{DD}=125V, R_L=7.5\Omega$ $V_{GS}=10V, R_G=3\Omega$	-	7	-	nS
Turn-on Rise Time	$t_r$		-	9	-	nS
Turn-Off Delay Time	$t_{d(off)}$		-	25	-	nS
Turn-Off Fall Time	$t_f$		-	5	-	nS
Total Gate Charge	$Q_g$	$V_{DS}=125V, I_D=20A,$ $V_{GS}=10V$	-	24	-	nC
Gate-Source Charge	$Q_{gs}$		-	9.5	-	nC
Gate-Drain Charge	$Q_{gd}$		-	5.6	-	nC
<b>Drain-Source Diode Characteristics</b>						
Diode Forward Voltage (Note 3)	$V_{SD}$	$V_{GS}=0V, I_S=20A$	-	-	1.2	V
Diode Forward Current (Note 2)	$I_S$		-	-	25	A
Reverse Recovery Time	$t_{rr}$	$T_J = 25^{\circ}\text{C}, I_F = I_S$ $di/dt = 100A/\mu s$ (Note 3)	-	45	-	nS
Reverse Recovery Charge	$Q_{rr}$		-	160	-	nC

**Notes:**

1. Repetitive Rating: Pulse width limited by maximum junction temperature.
2. Surface Mounted on FR4 Board,  $t \leq 10$  sec.
3. Pulse Test: Pulse Width  $\leq 300\mu s$ , Duty Cycle  $\leq 2\%$ .
4. Guaranteed by design, not subject to production
5. EAS condition :  $T_J=25^{\circ}\text{C}, V_{DD}=50V, V_G=10V, L=0.5\text{mH}, R_g=25\Omega$

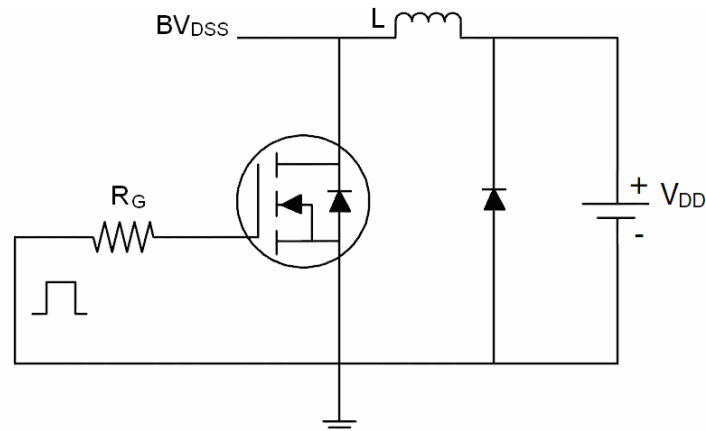
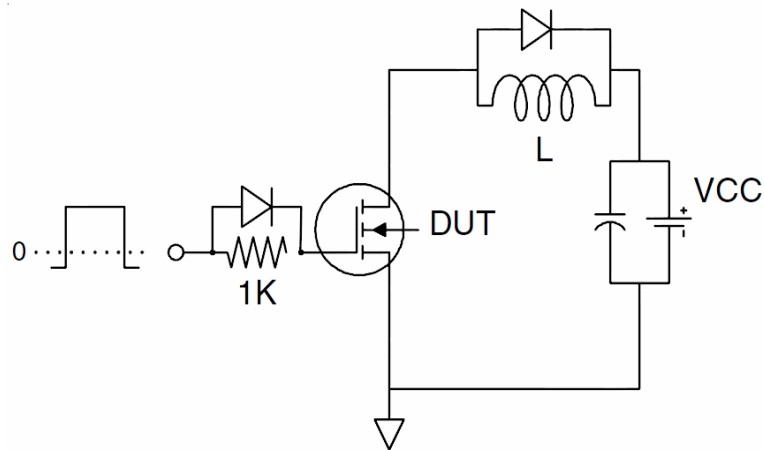
**Test Circuit**
**1) E<sub>AS</sub> test Circuit**

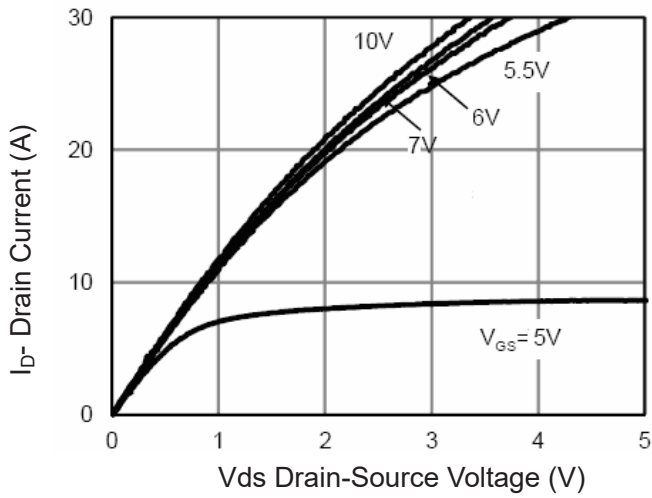
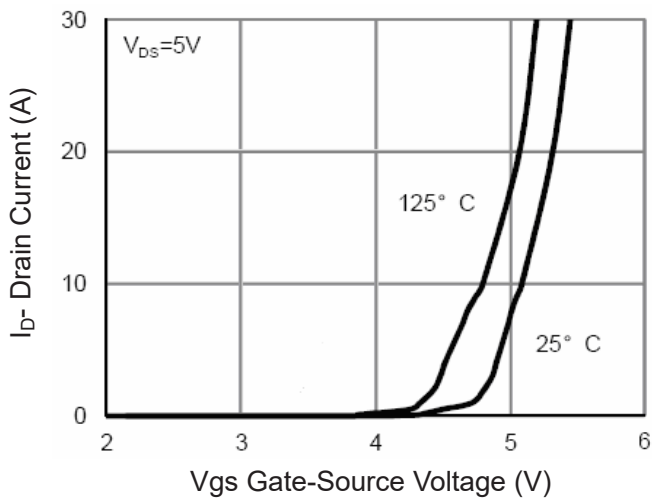
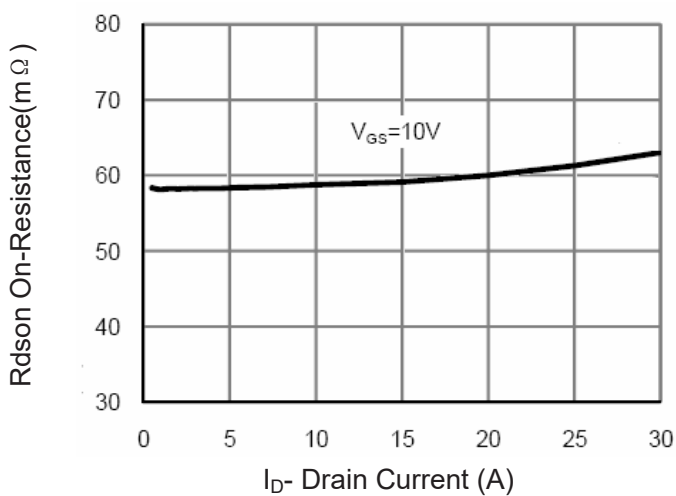
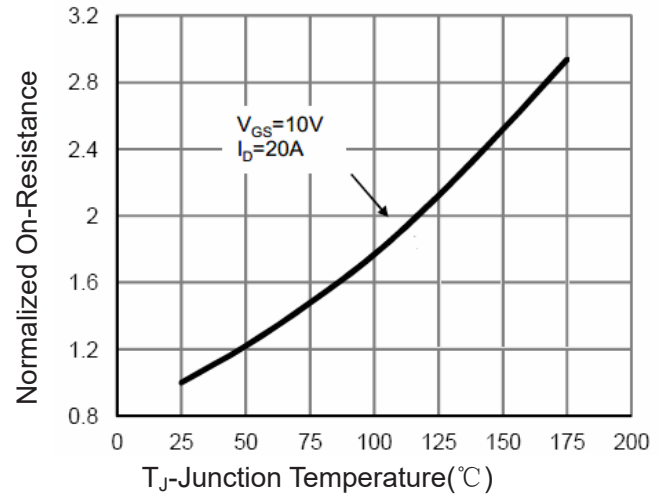
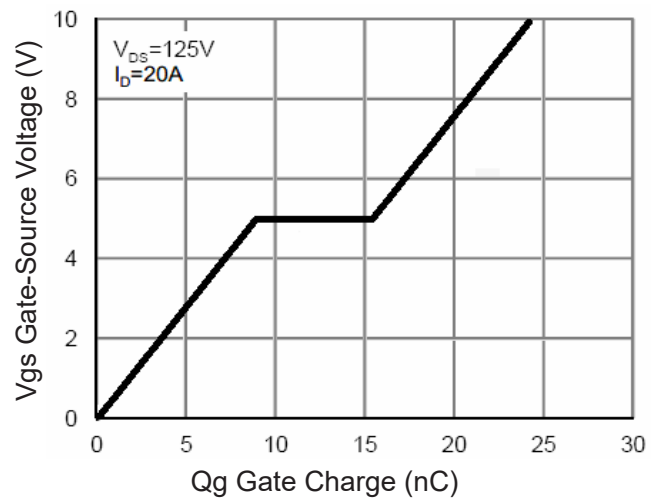
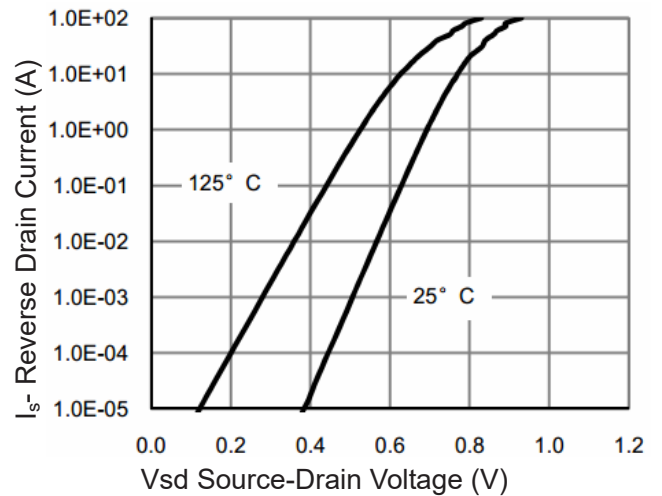
**2) Gate charge test Circuit**

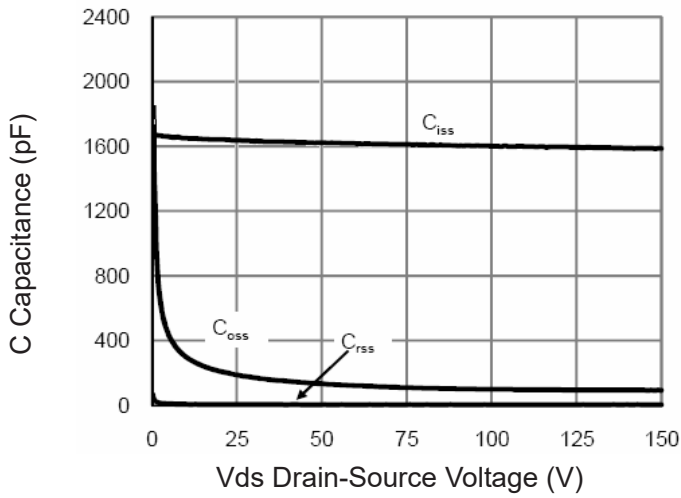
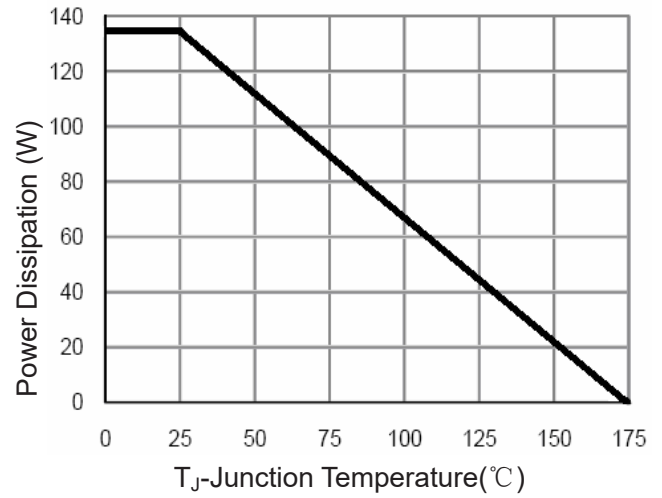
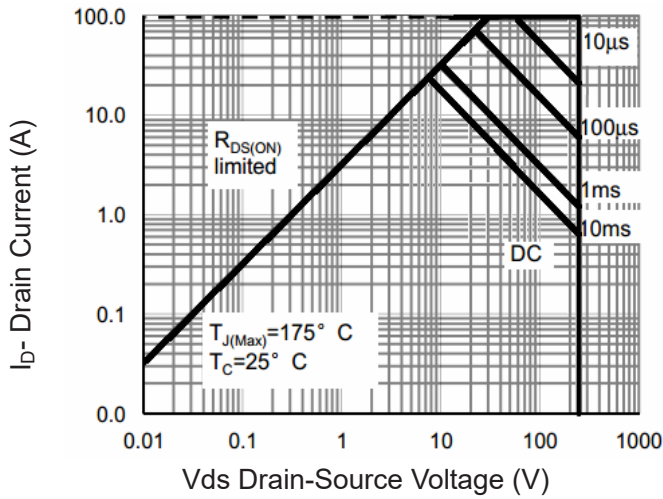
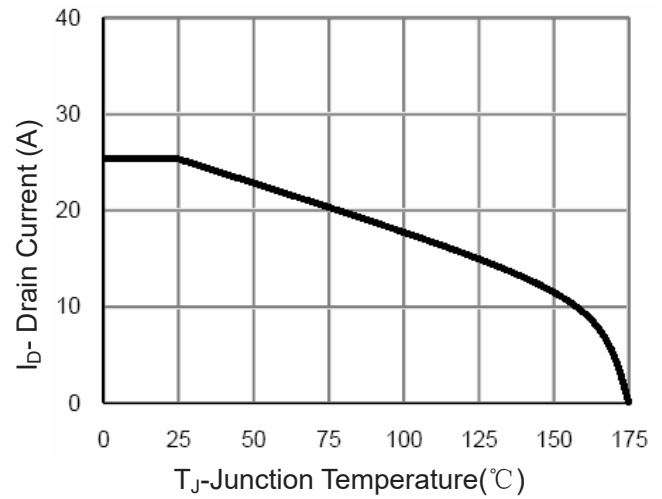
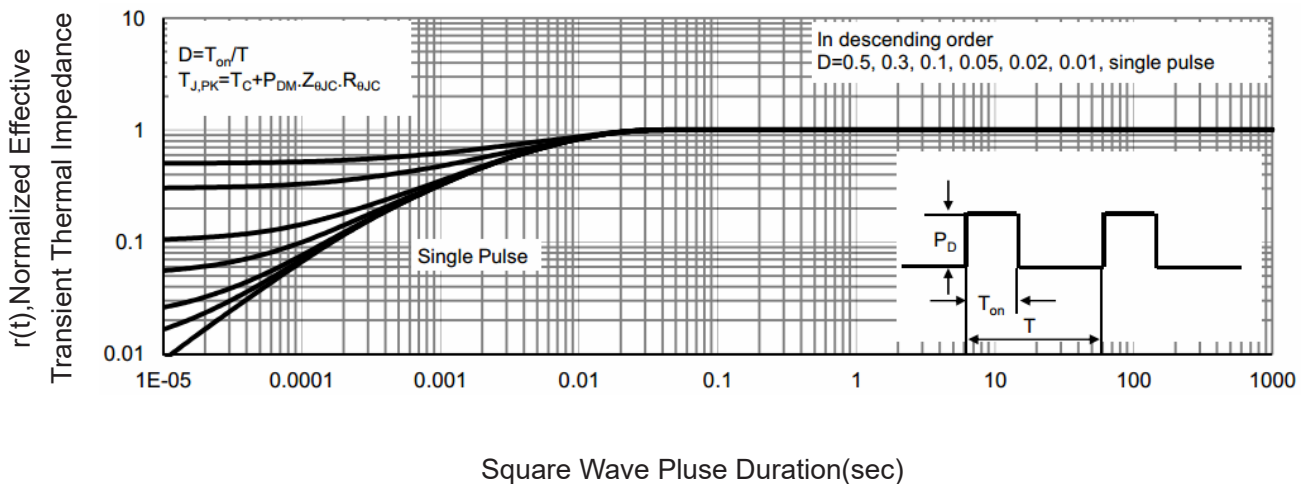
**3) Switch Time Test Circuit**

**Typical Electrical and Thermal Characteristics**

**Figure 1 Output Characteristics**

**Figure 2 Transfer Characteristics**

**Figure 3 Rdson- Drain Current**

**Figure 4 Rdson-Junction Temperature**

**Figure 5 Gate Charge**

**Figure 6 Source- Drain Diode Forward**

**Figure 7 Capacitance vs Vds**

**Figure 9 Power De-rating**

**Figure 8 Safe Operation Area**

**Figure 10 Current De-rating**

**Figure 11 Normalized Maximum Transient Thermal Impedance**